



AGENTS



8630



1

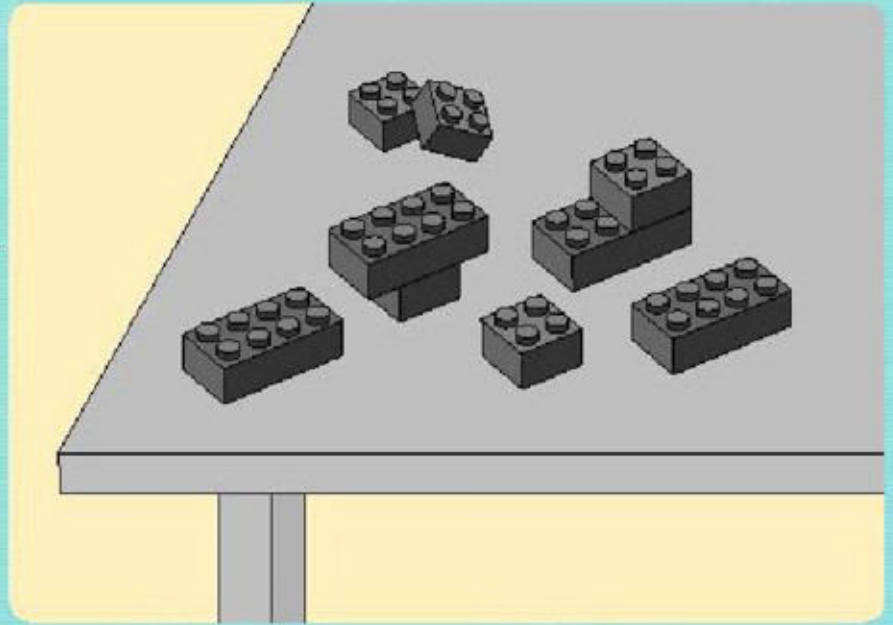
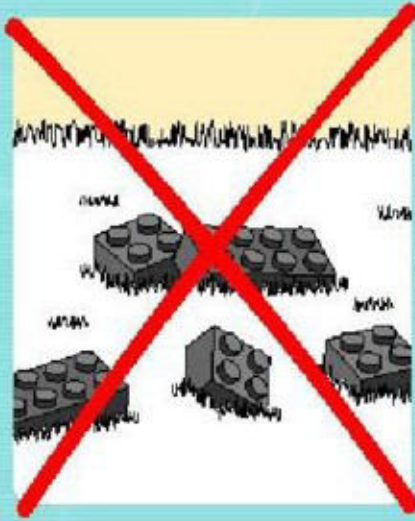

2





3

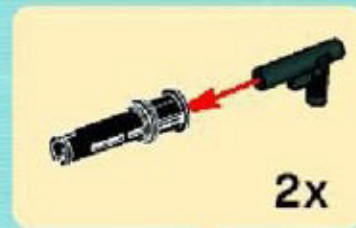
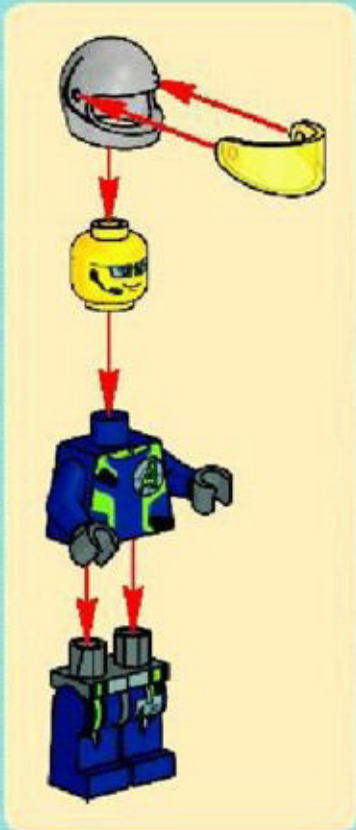

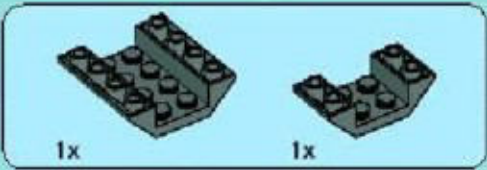
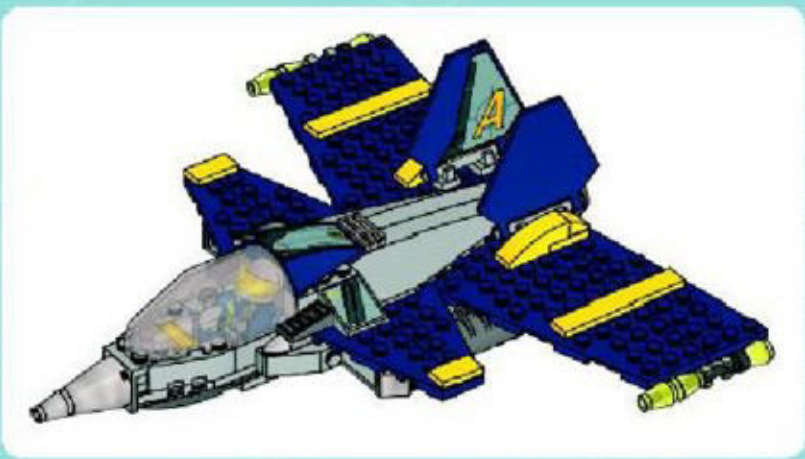

1

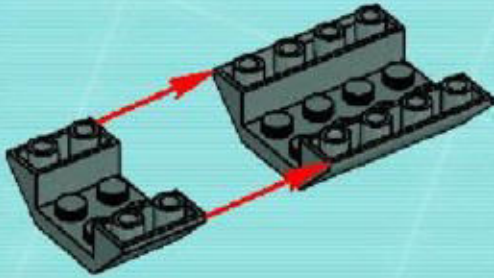

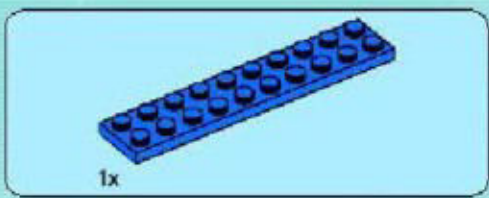

2

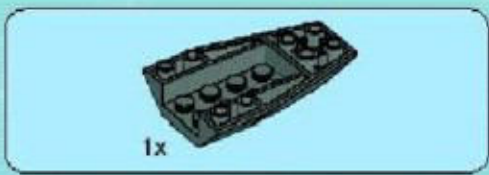
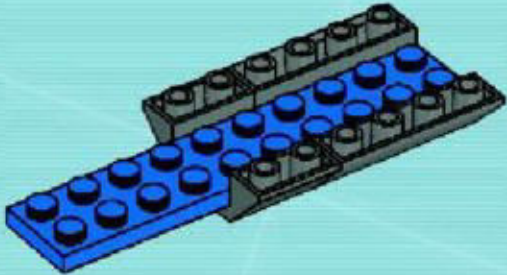

3

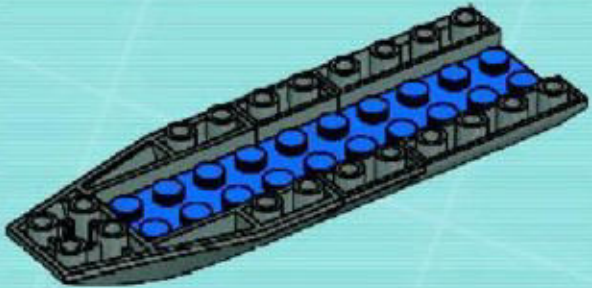

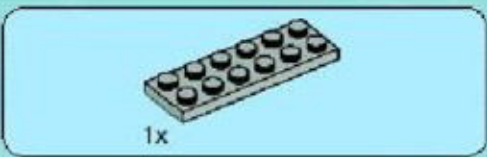

4

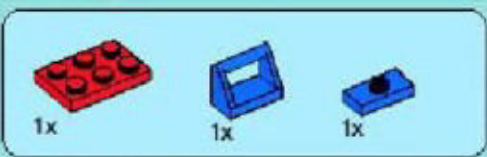
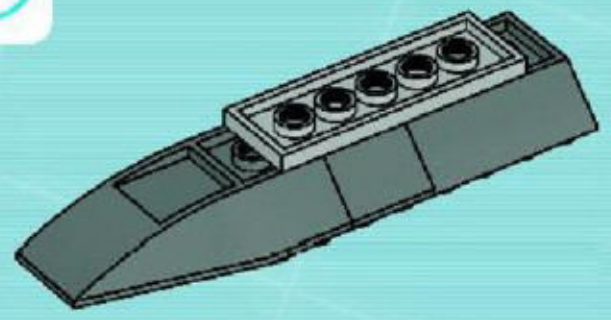

5

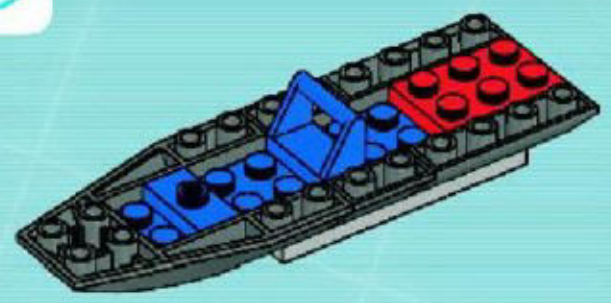

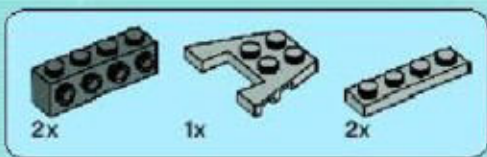

6

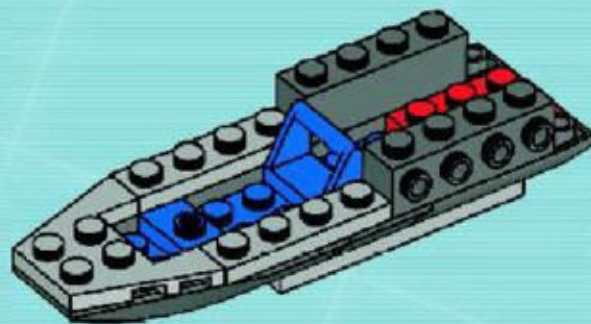

7

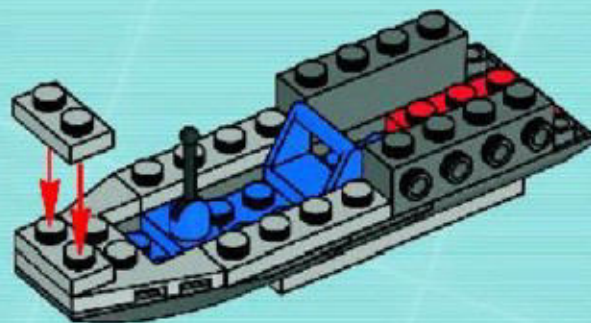

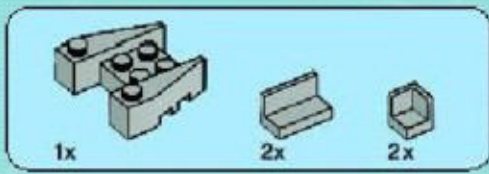

8

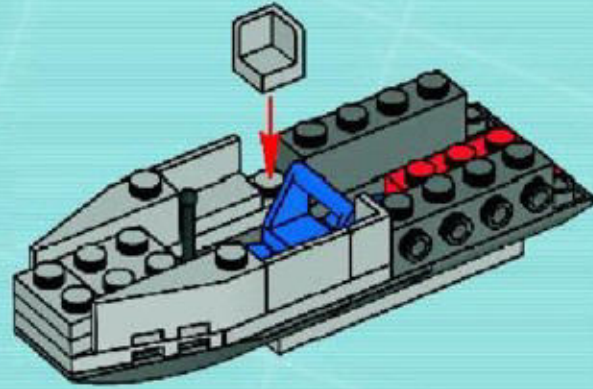

9

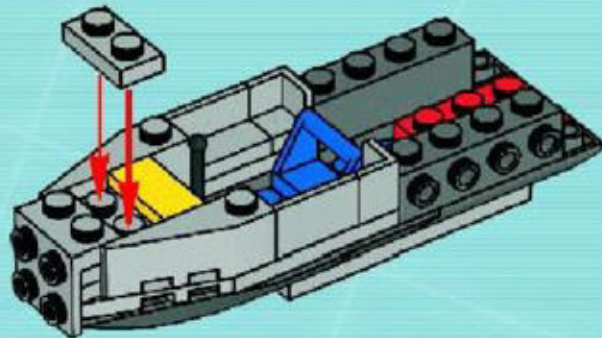

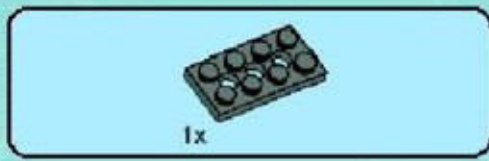
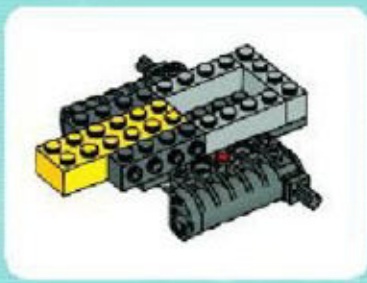

1

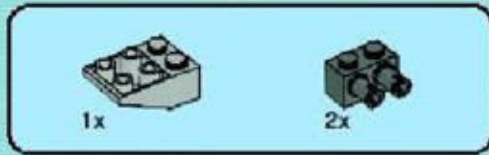

2

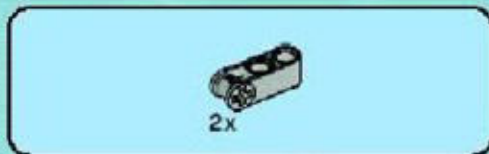
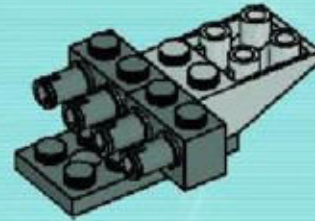

3

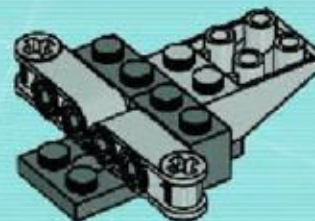



1x

4

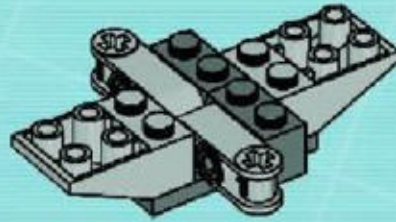

2x



2x

5

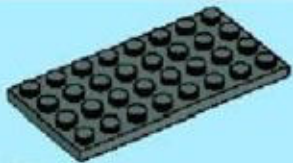
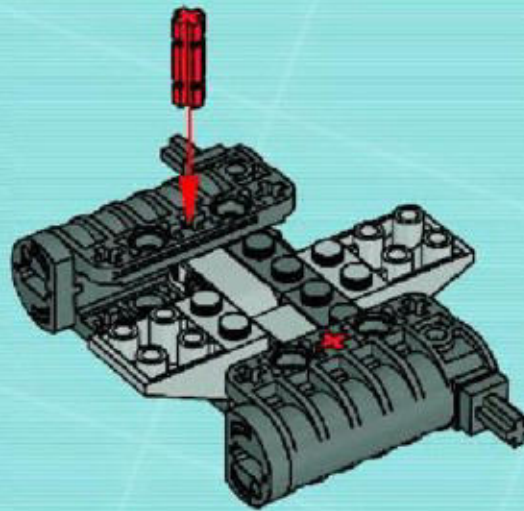

1x

6

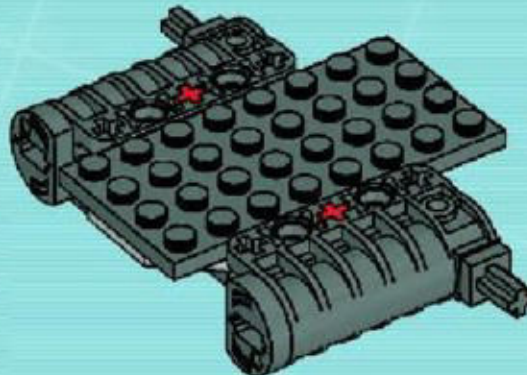

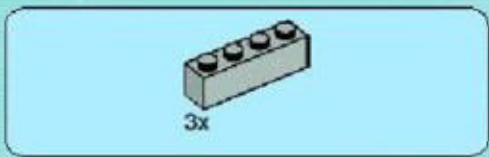

7

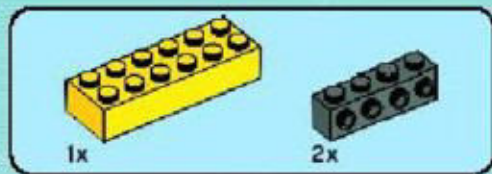
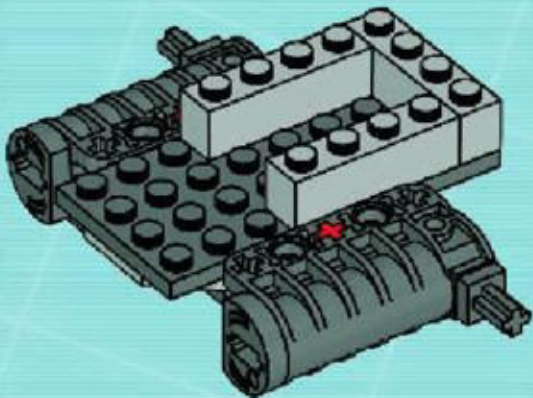

8

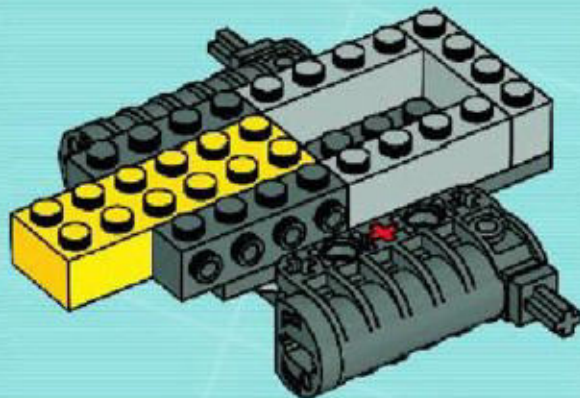

10

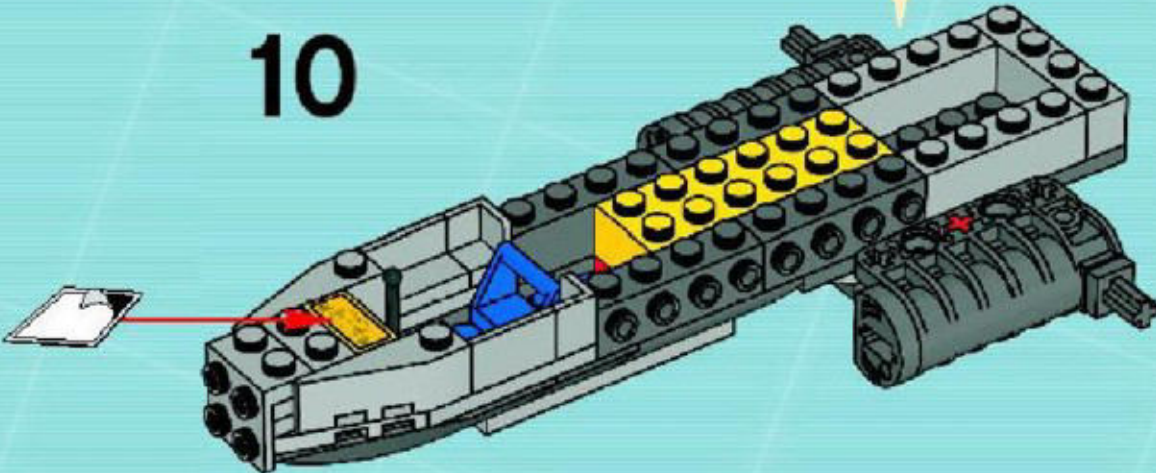

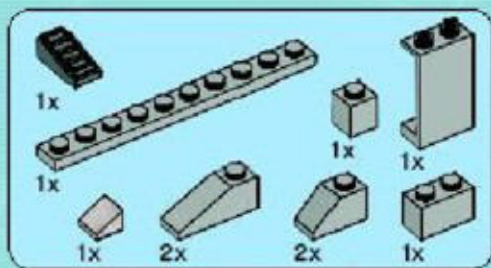

11

1

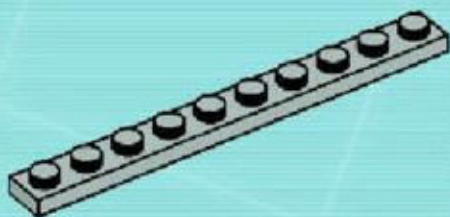

2

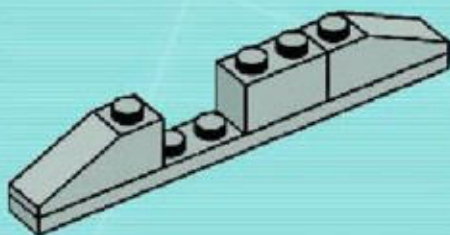

3

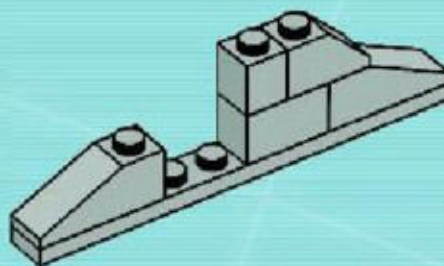

4

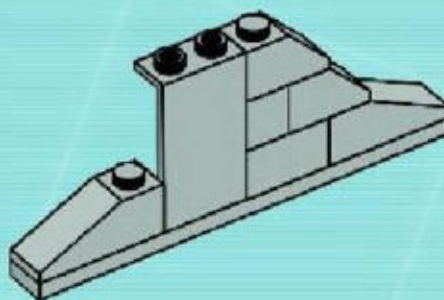

5

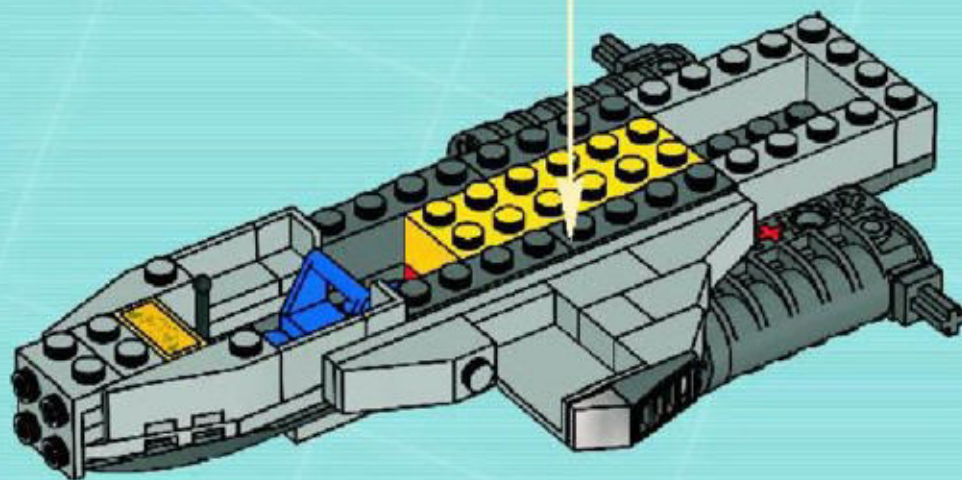
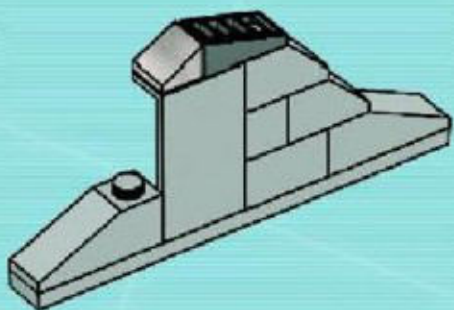

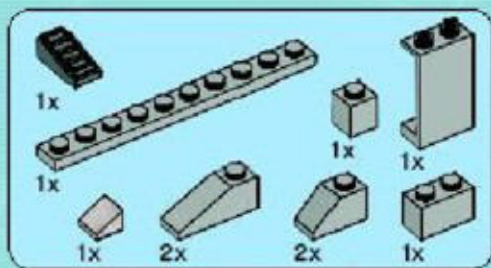

12

1

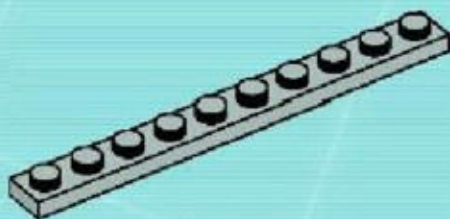

2

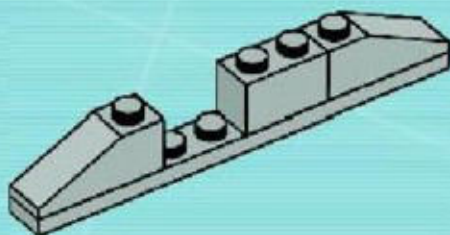

3

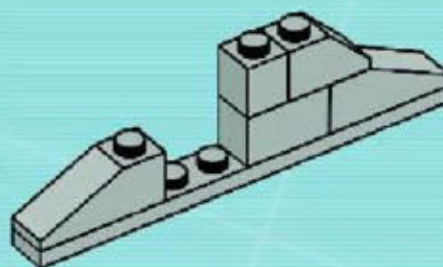

4

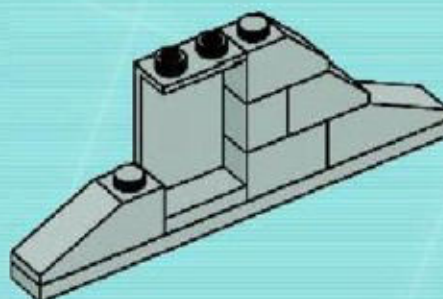

5

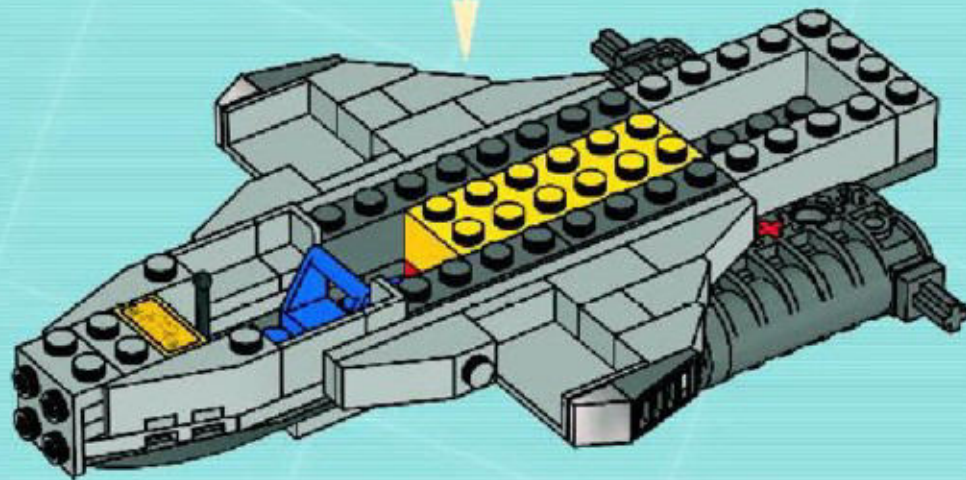
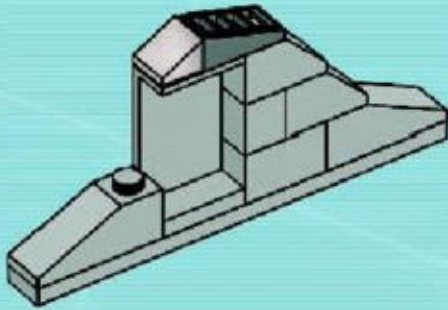



13

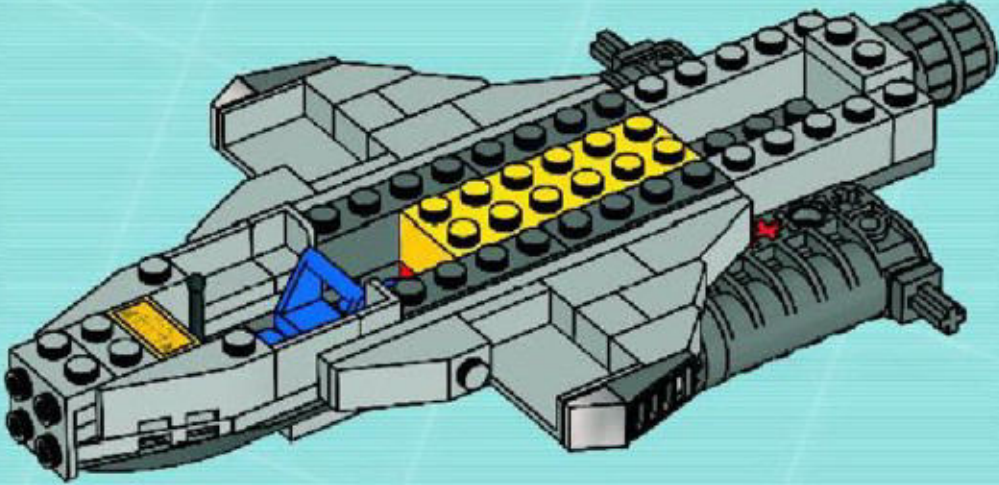
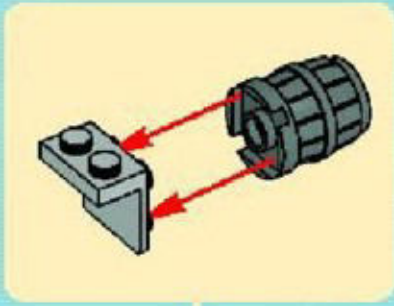

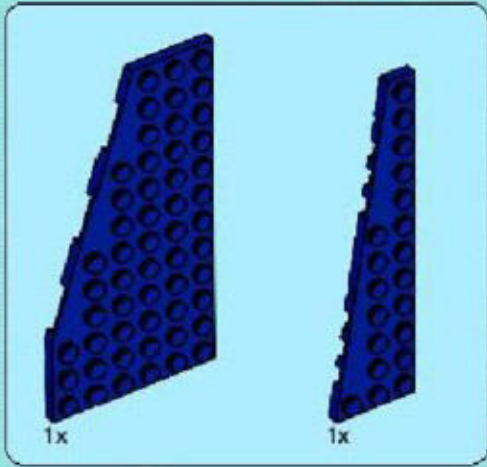

1

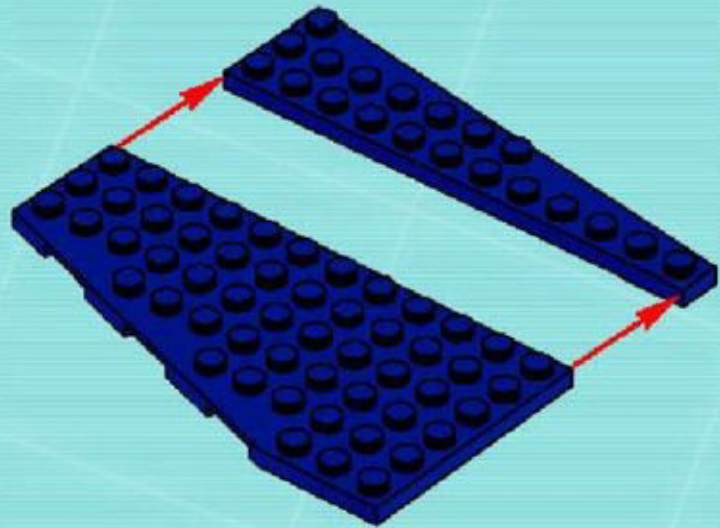

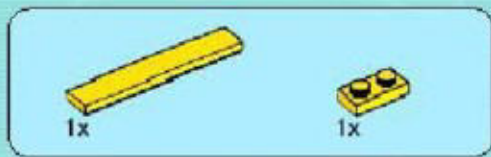

2

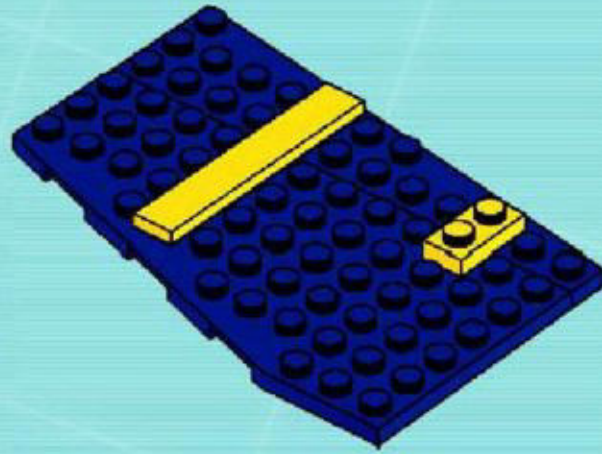

3

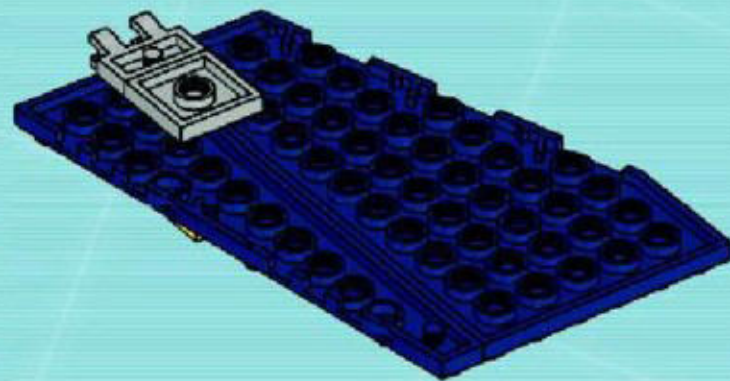



1x

4

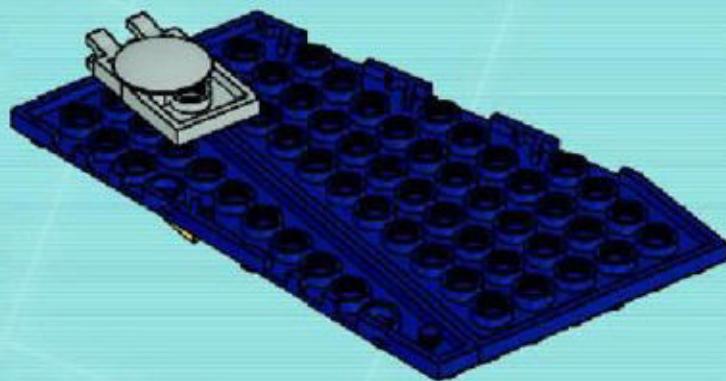

1x



1x



2x

5

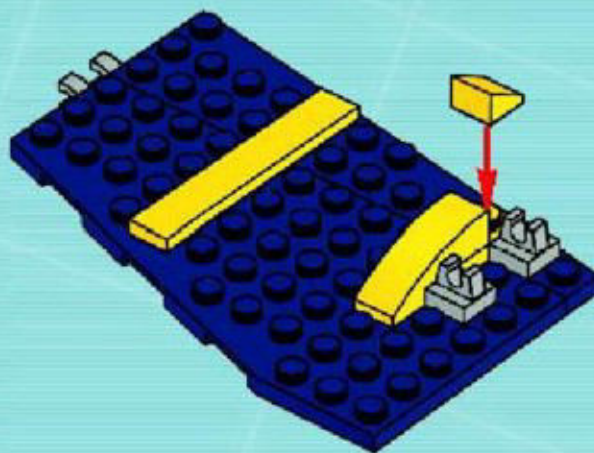

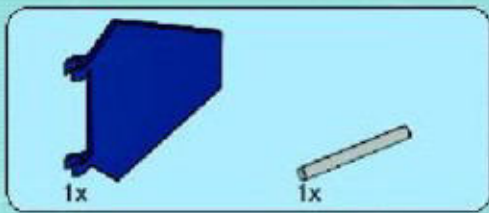

6

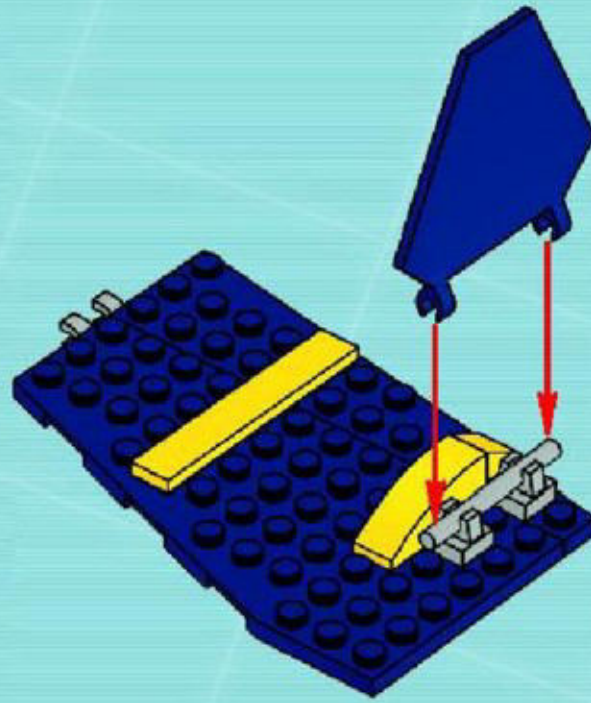

7

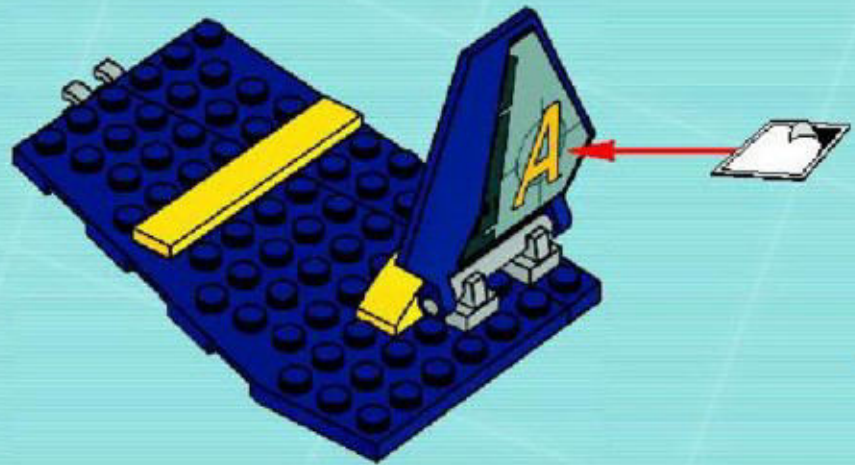

14

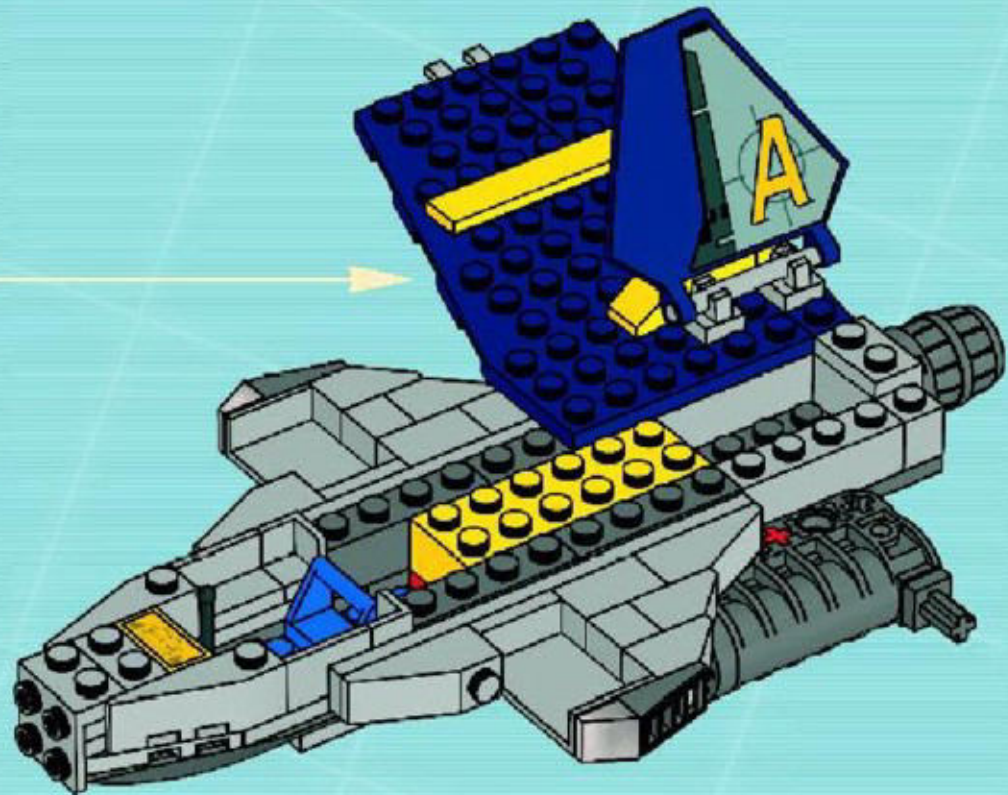

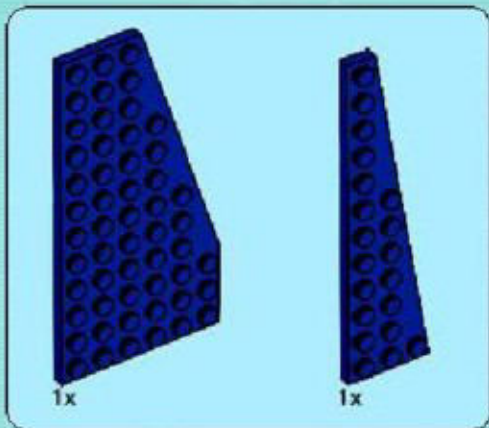

1

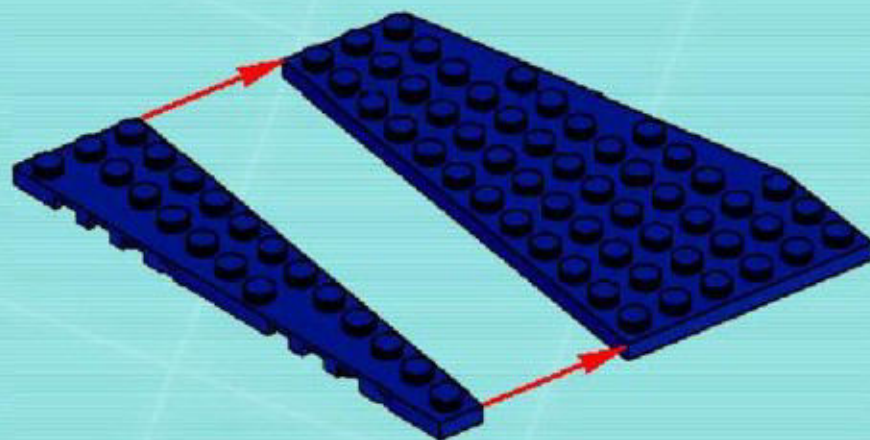

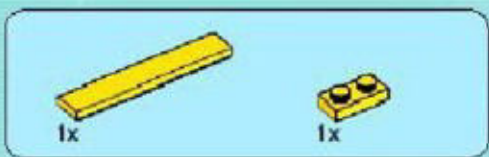

2

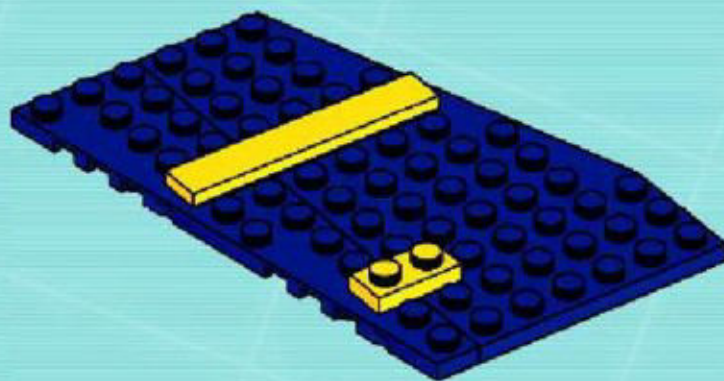

3

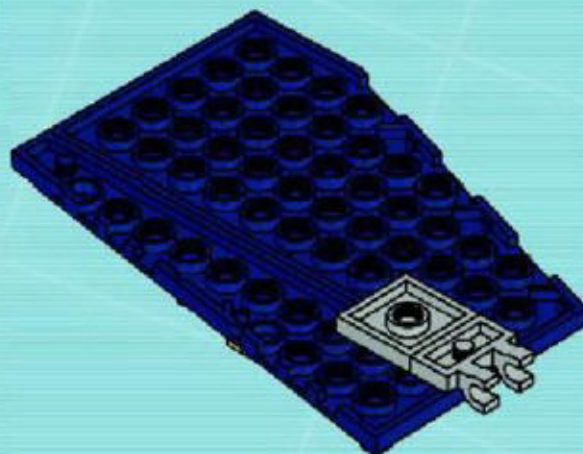



1x

4

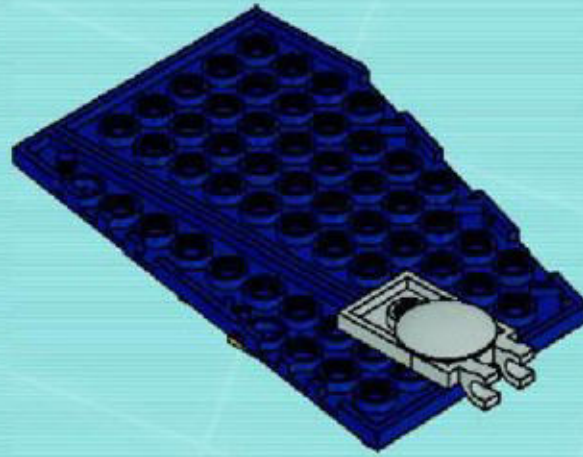

1x



2x



1x

5

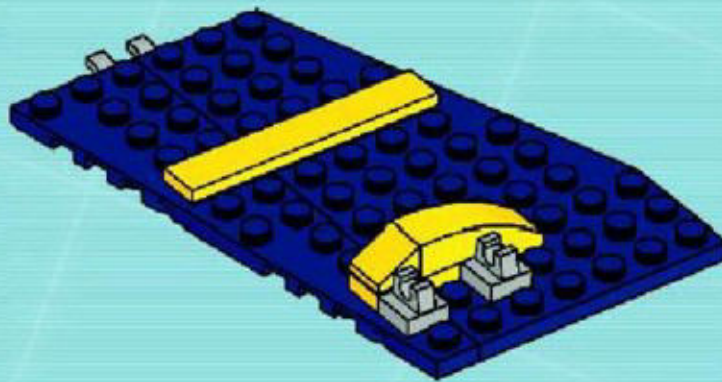

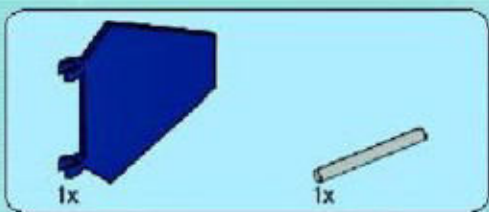

6

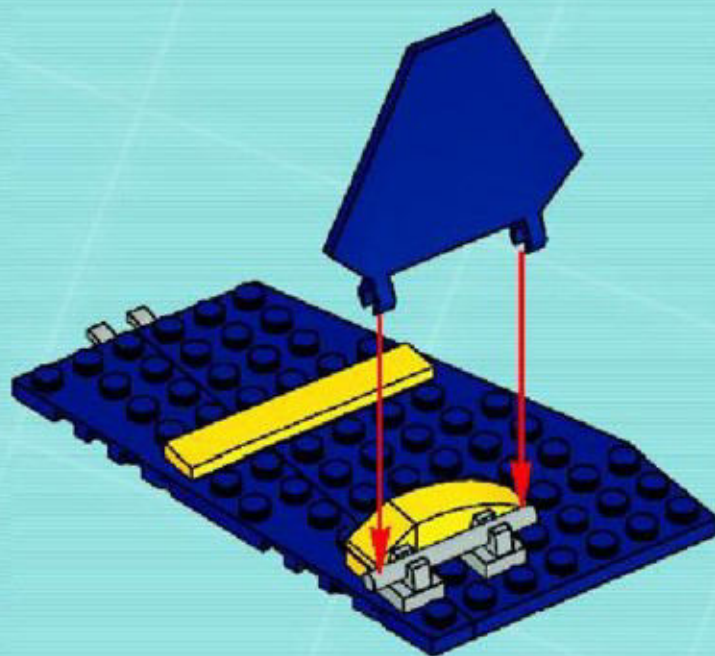

15

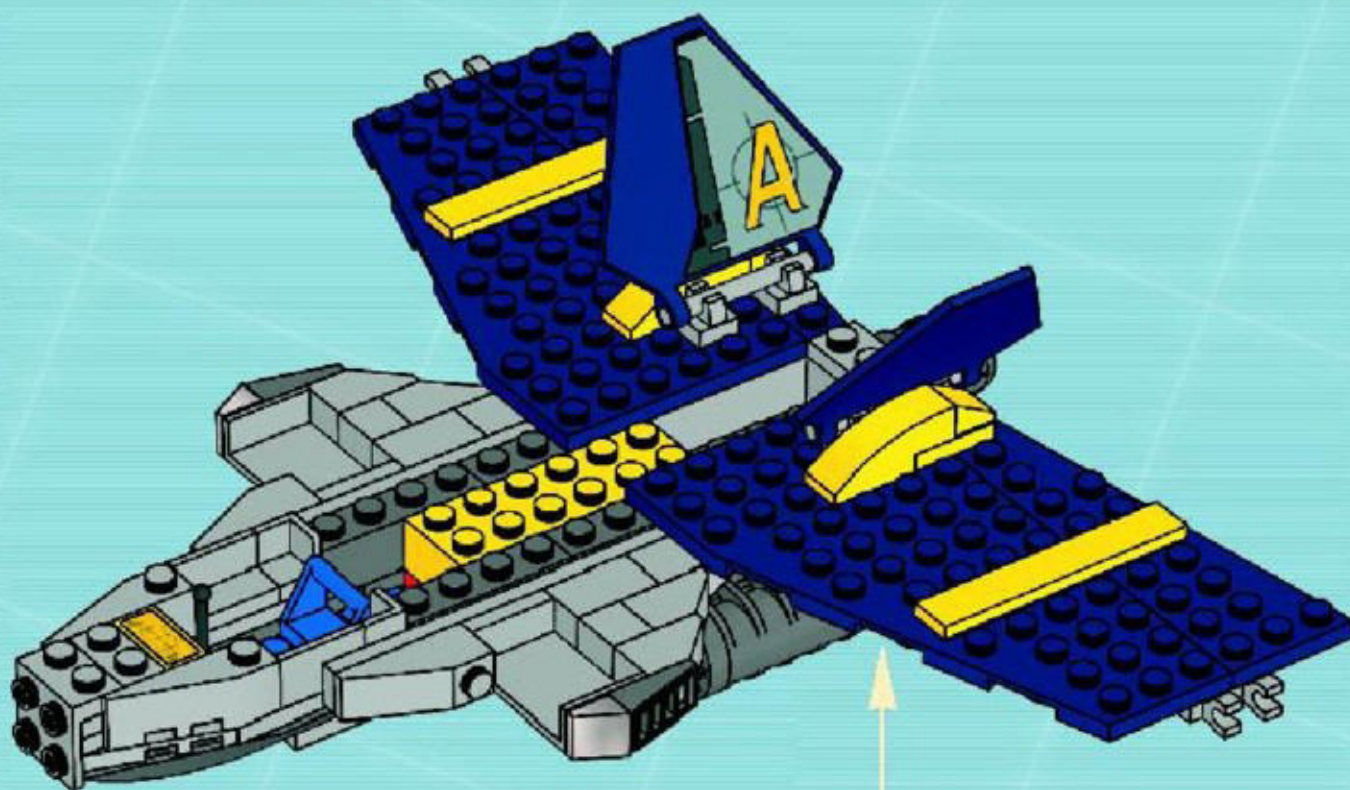

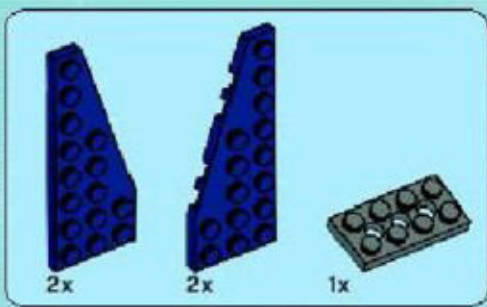

16

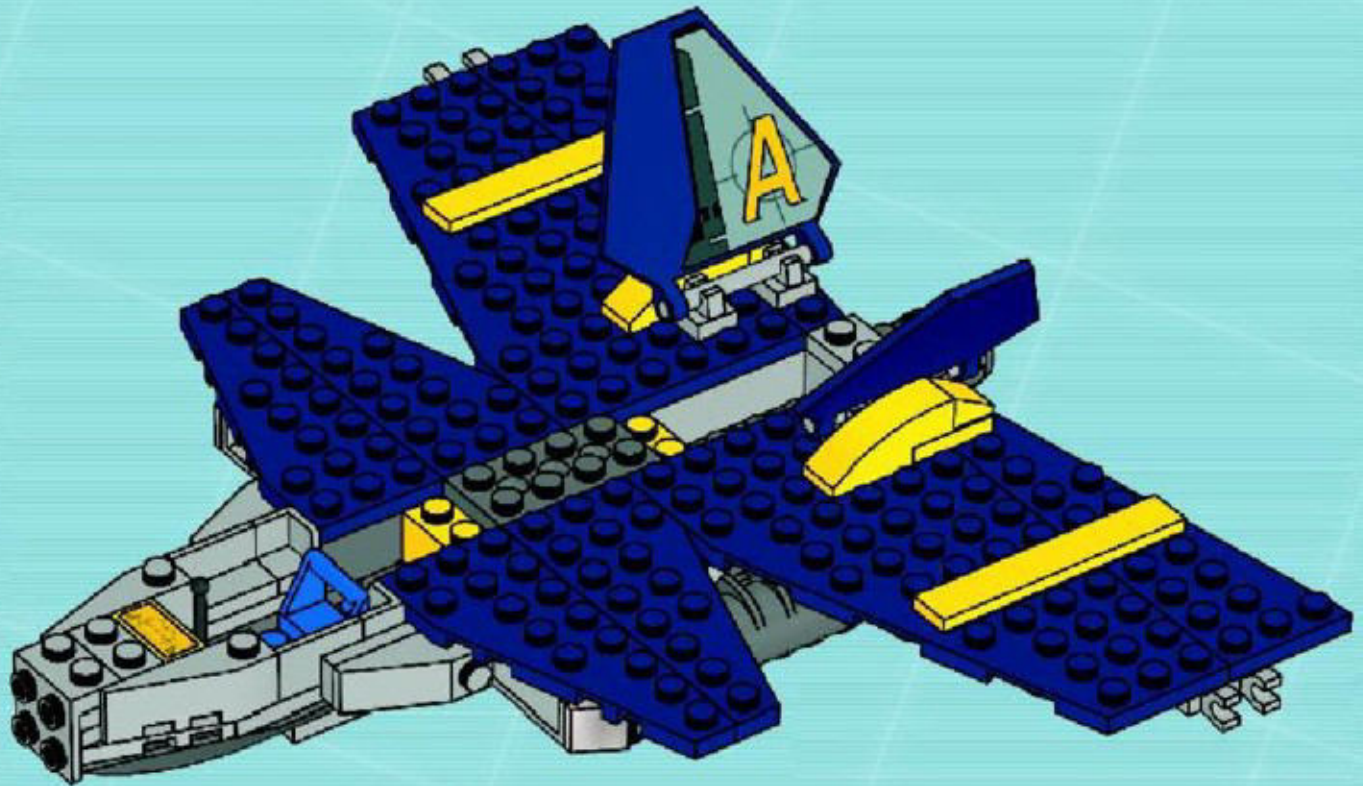

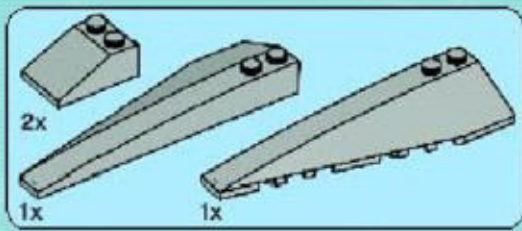

17

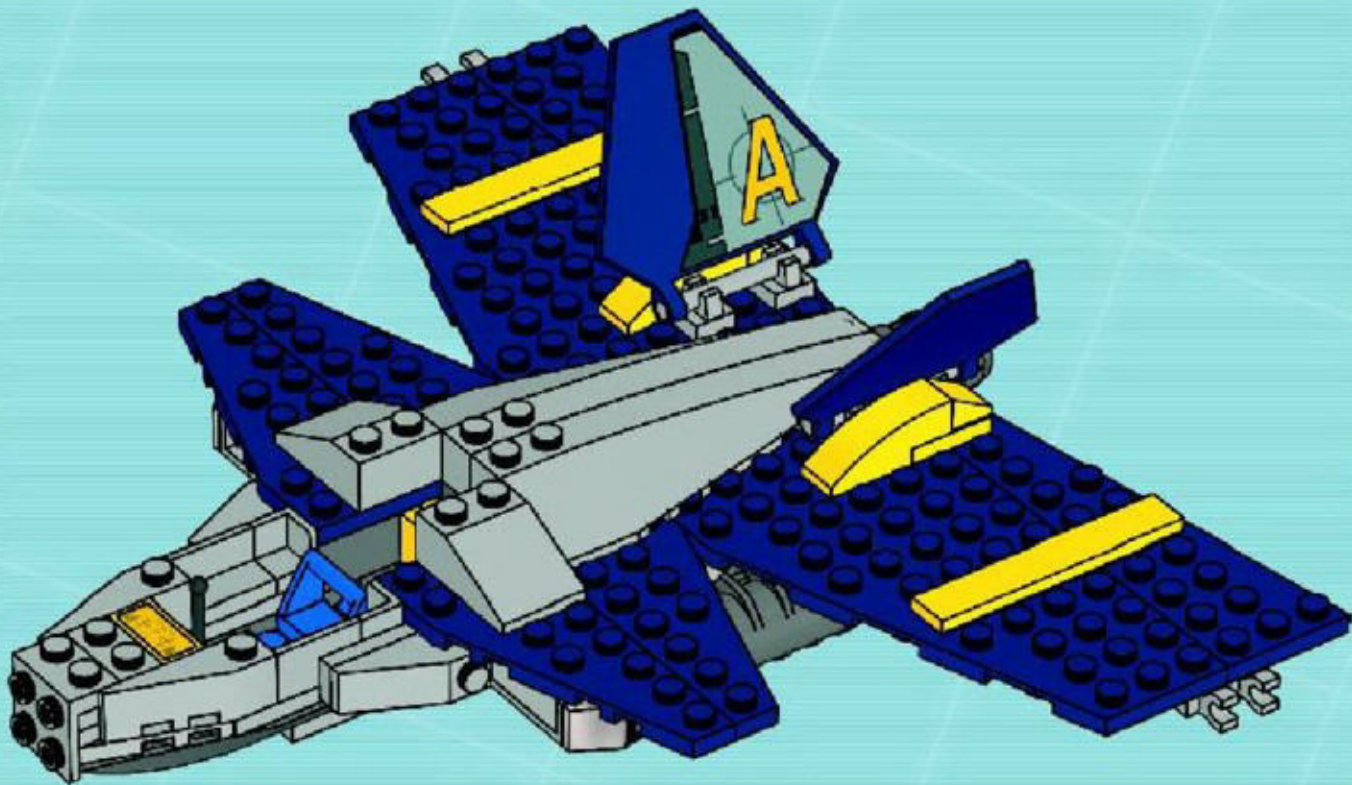



2x

18

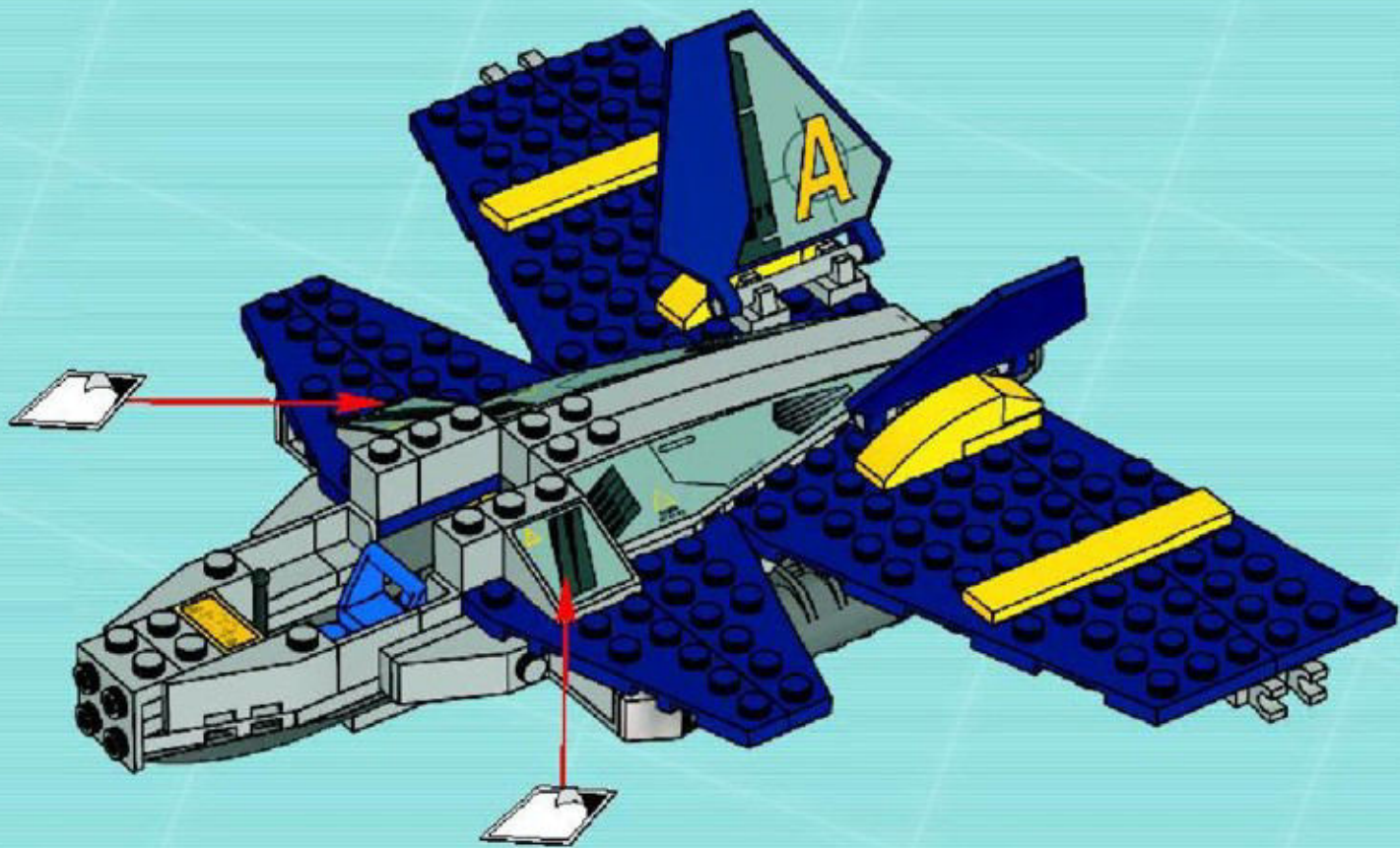

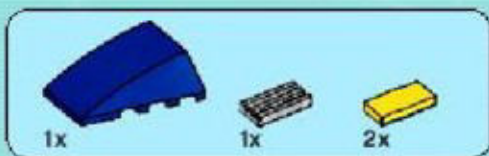

19

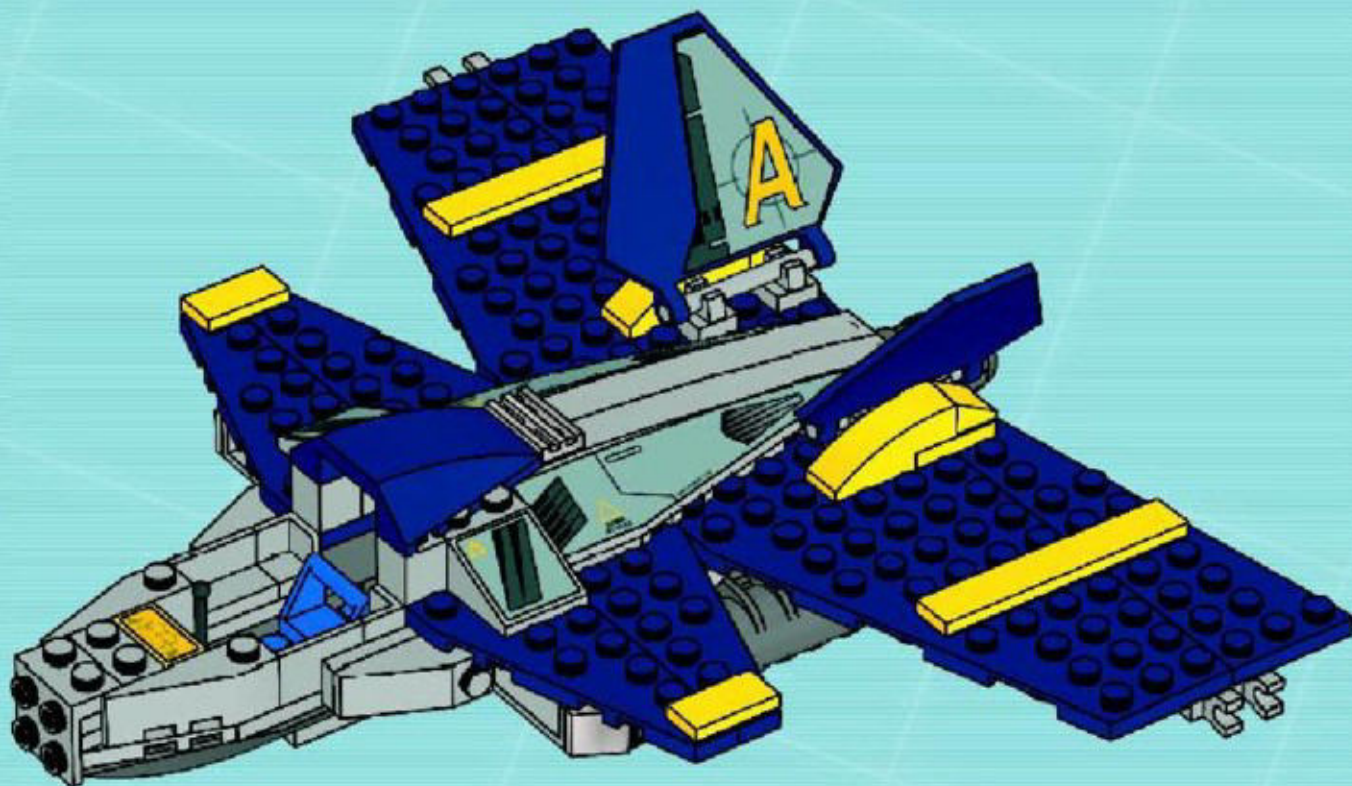



20

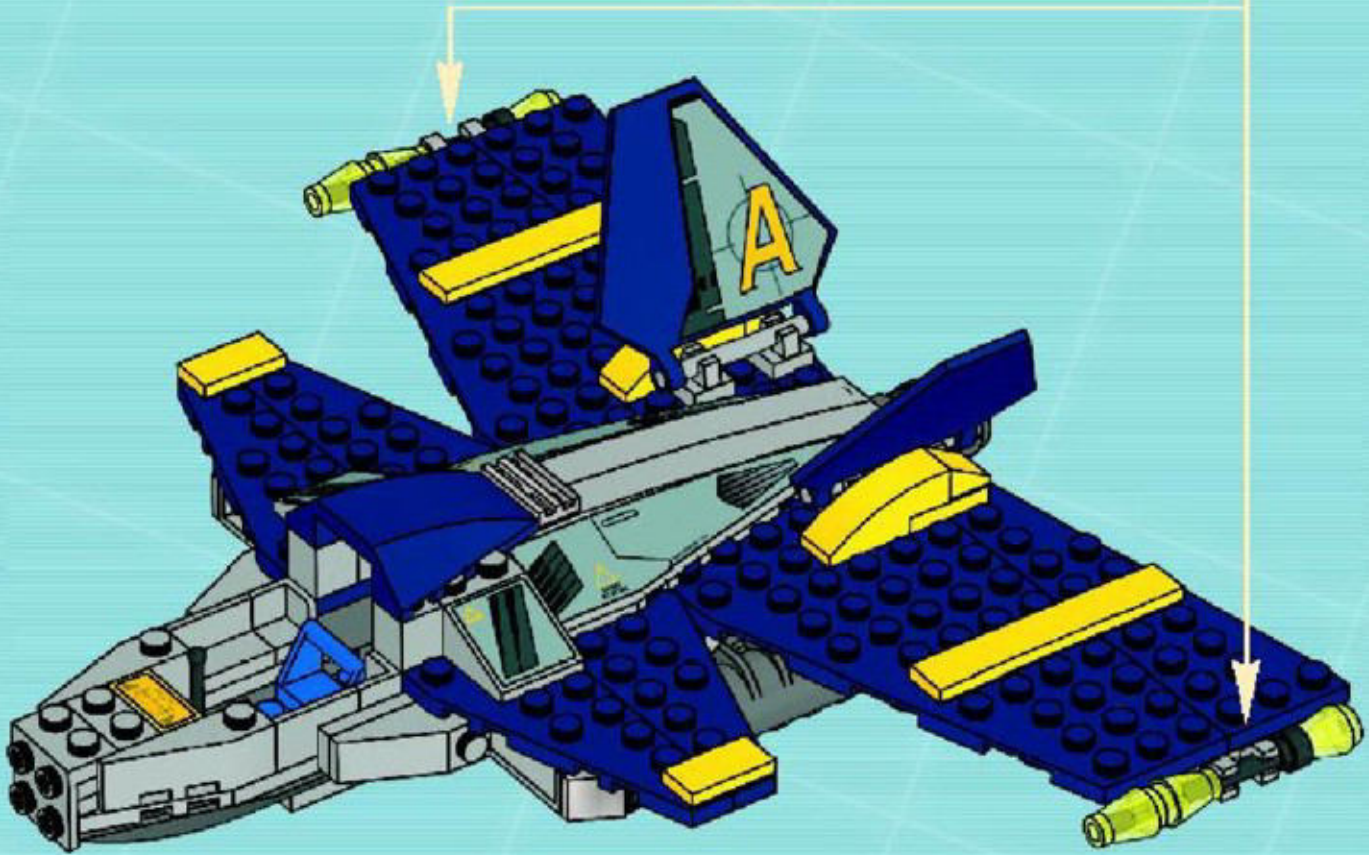
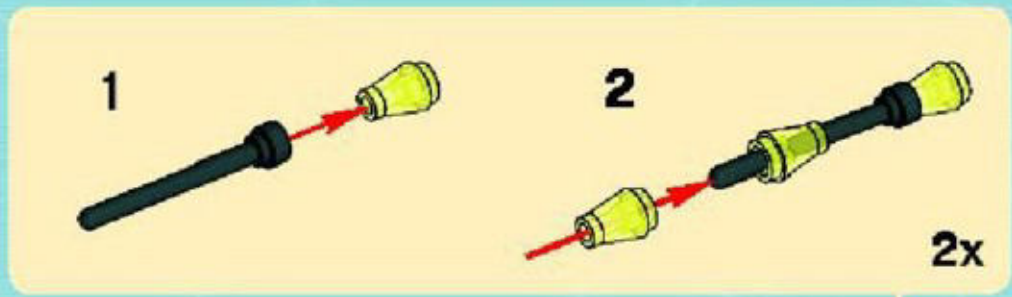



2x



2x

21

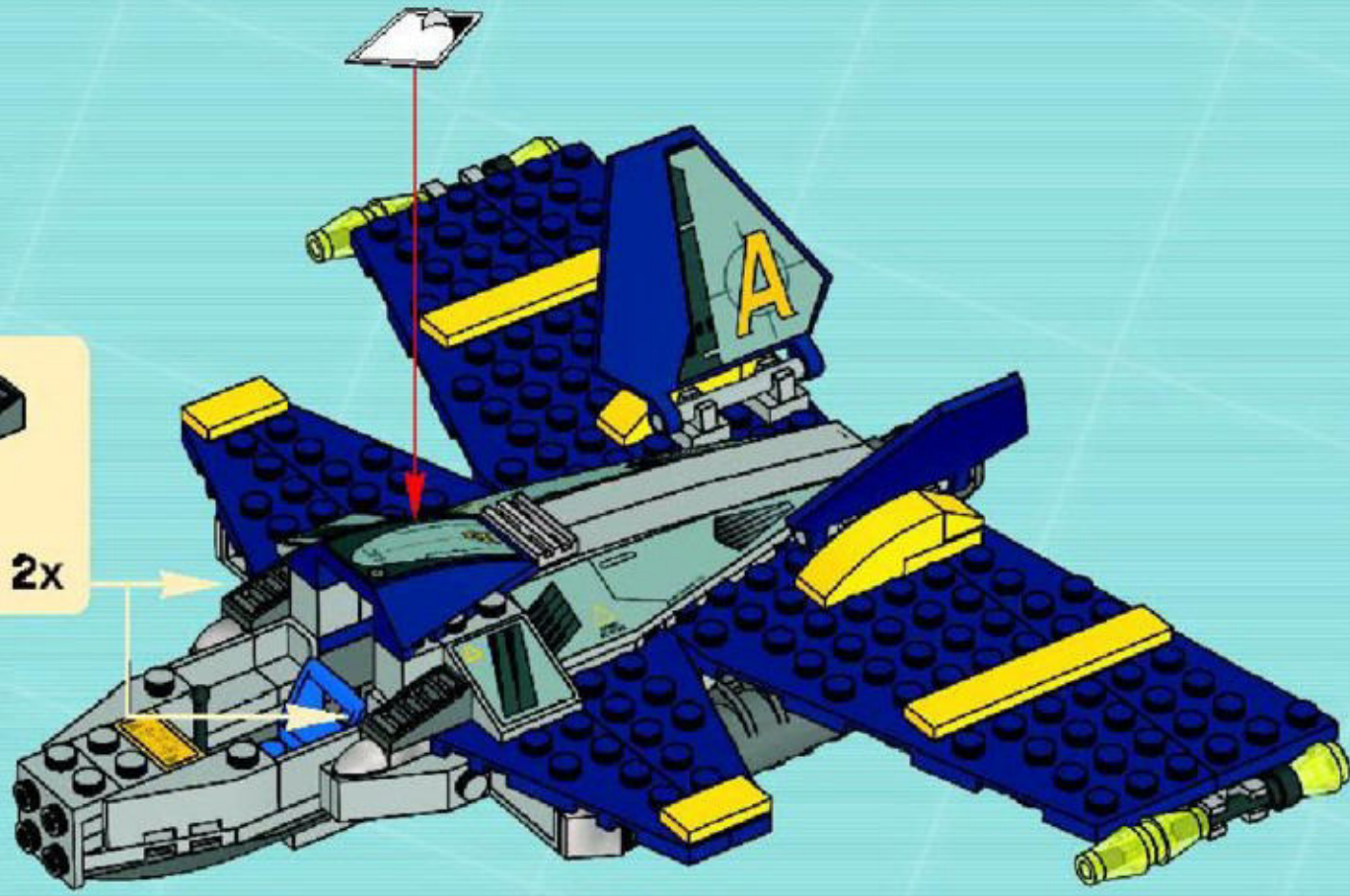
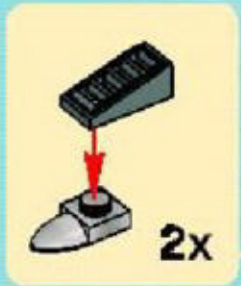

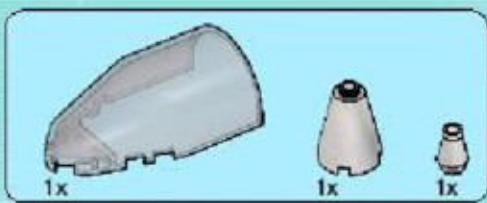

22

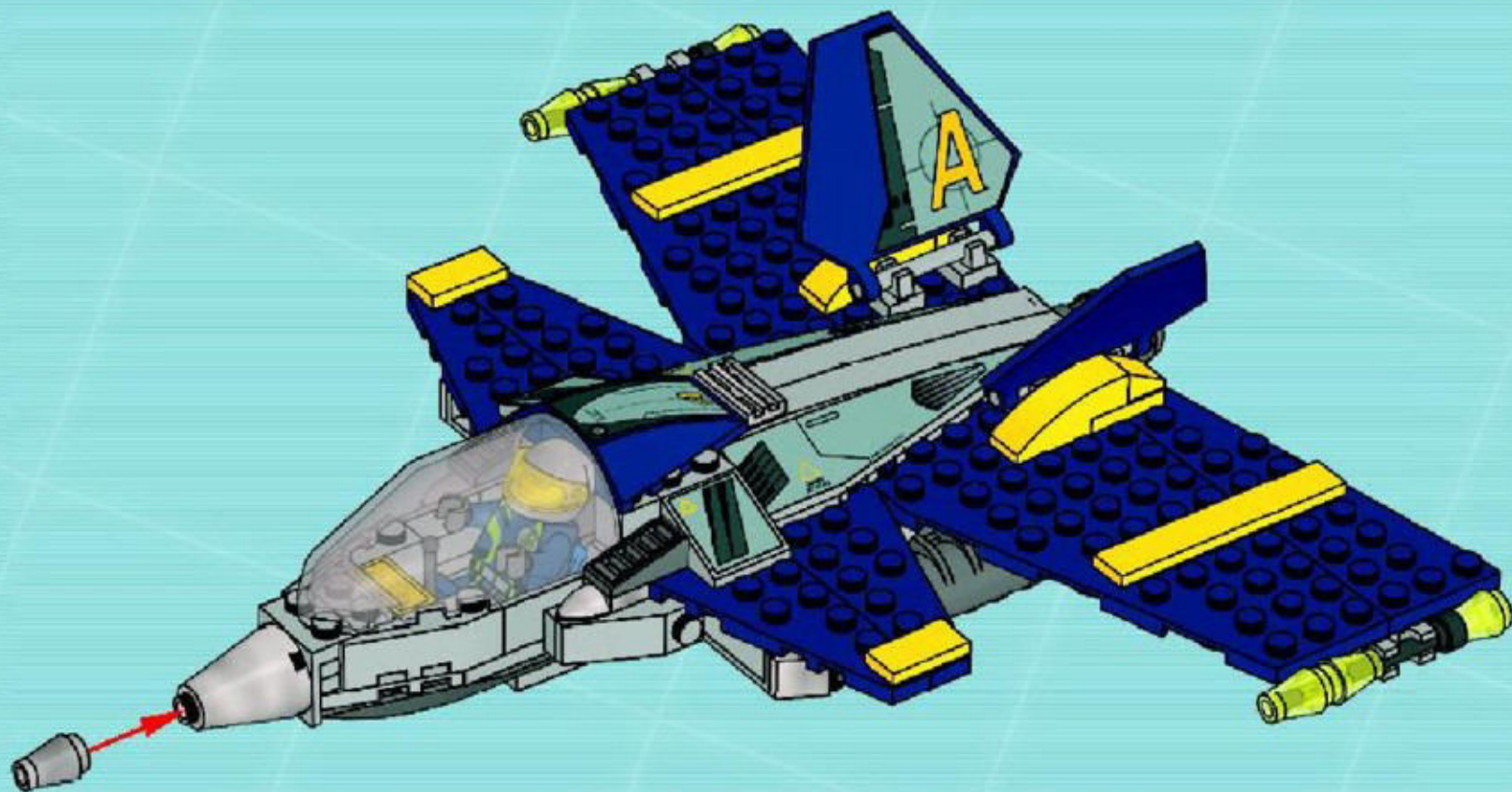



23

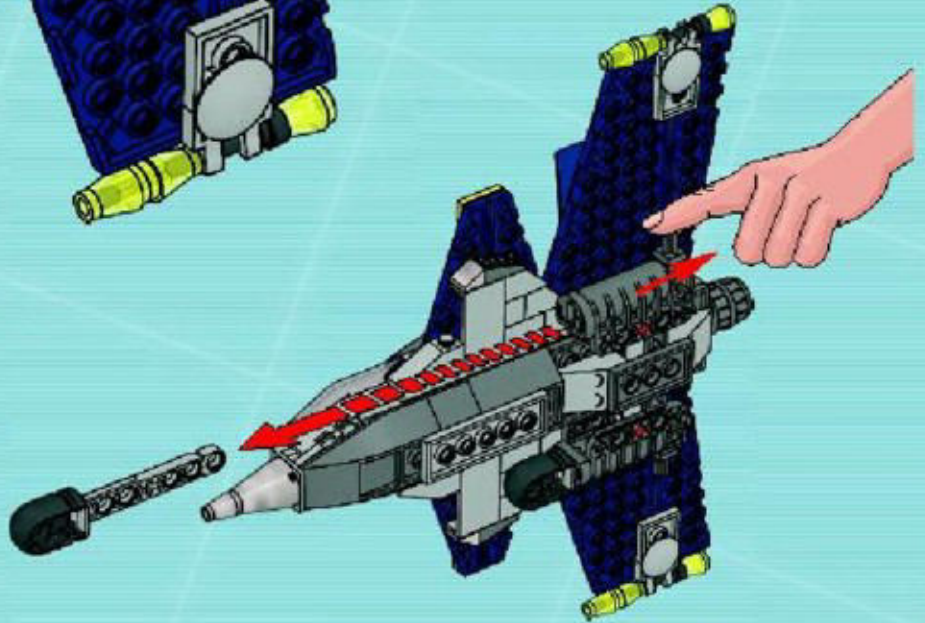
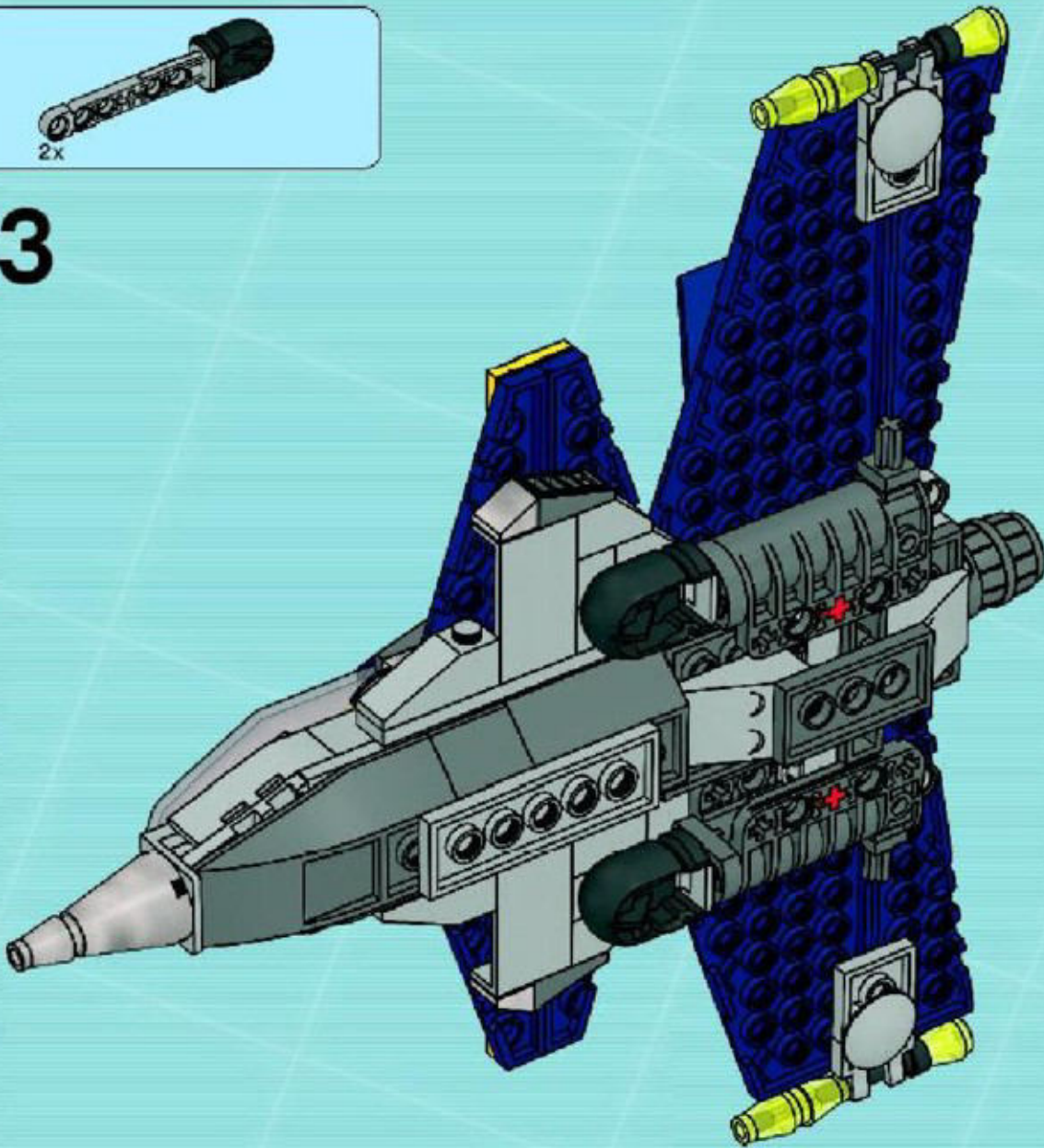

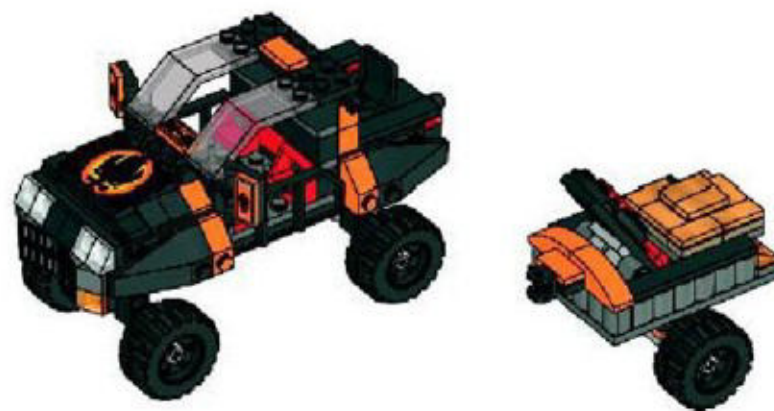

1

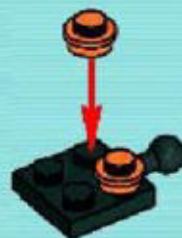



2

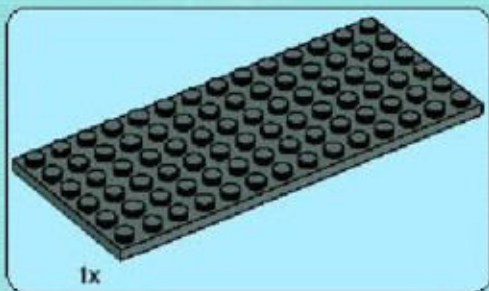
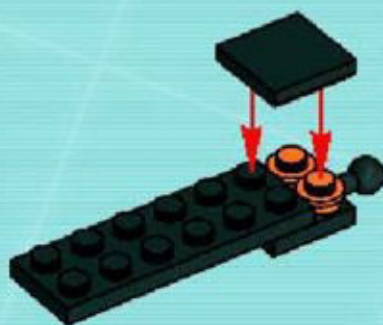

3

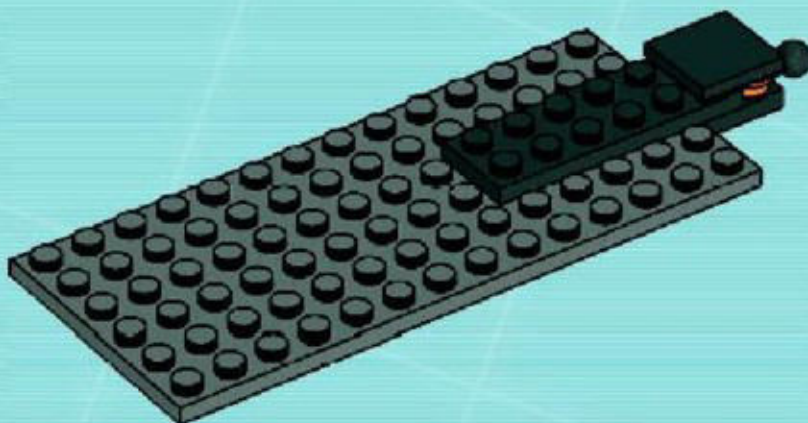



4

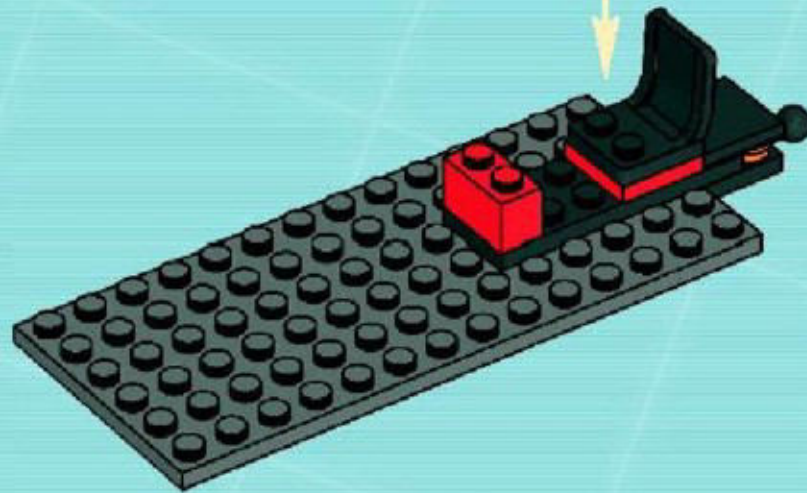
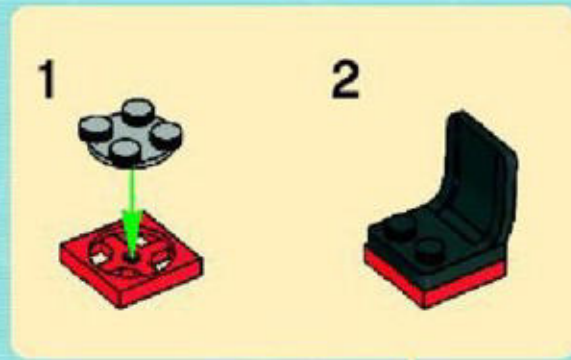

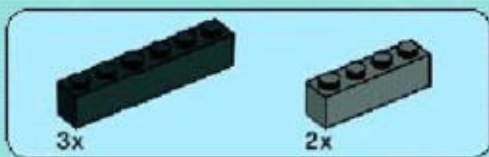

5

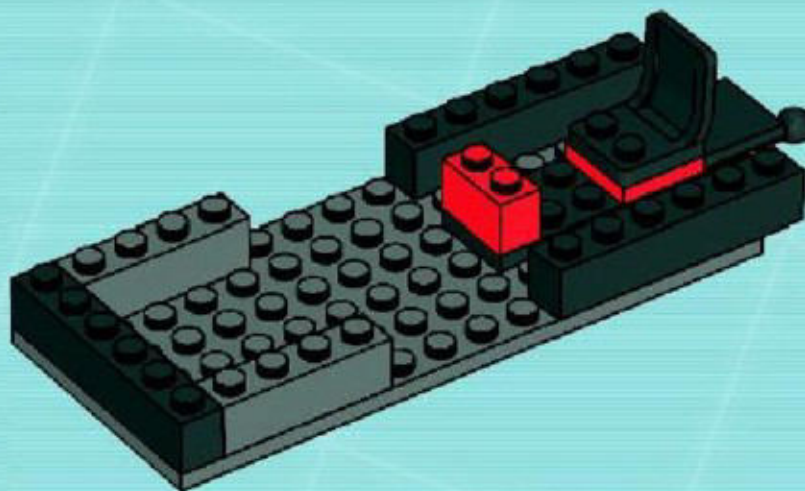

6

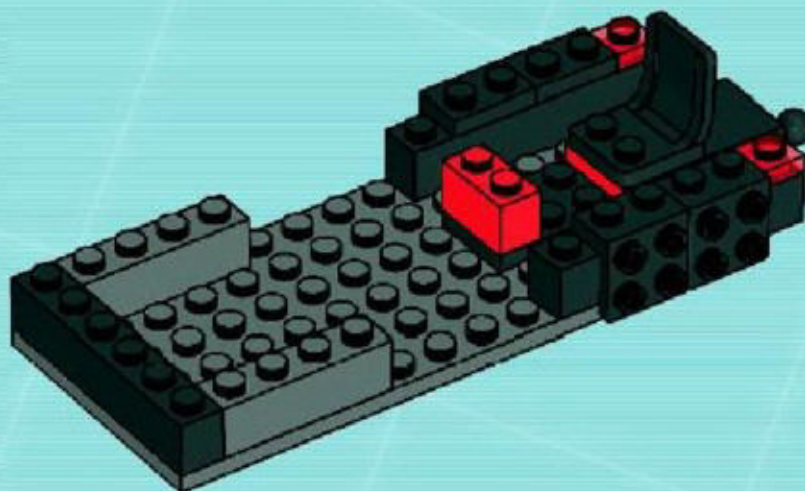



7

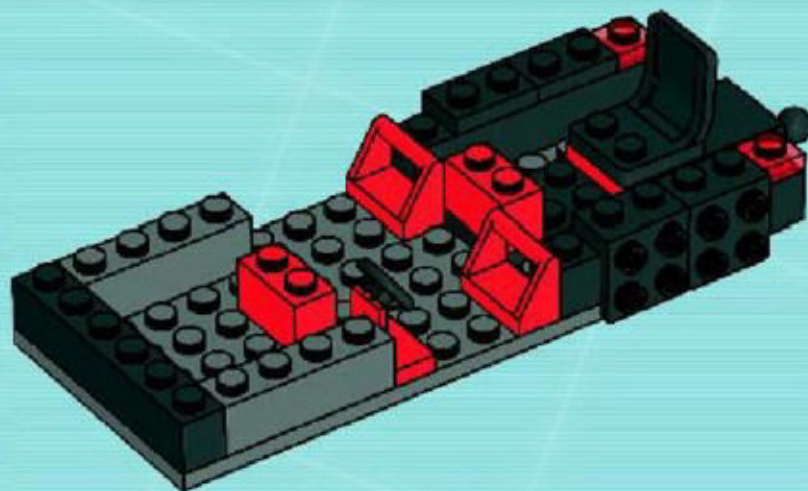

8

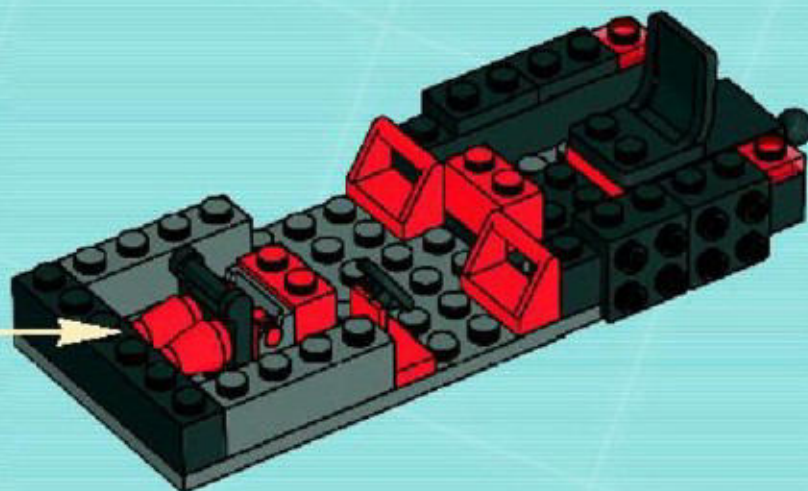
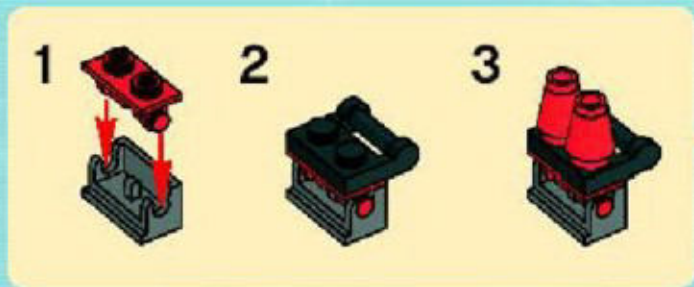



6x

9

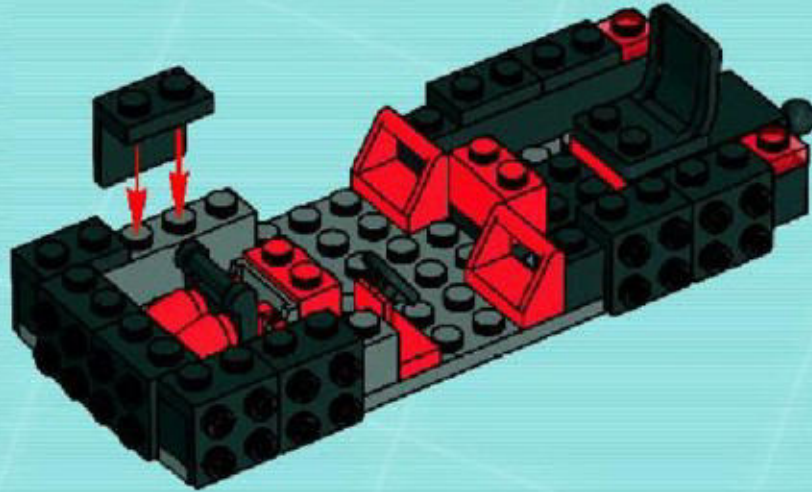

2x



2x

10

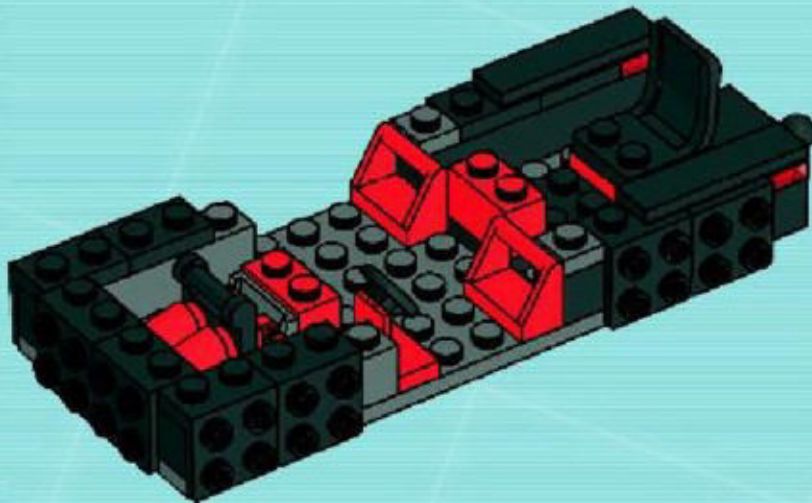

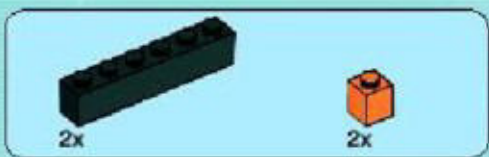

11

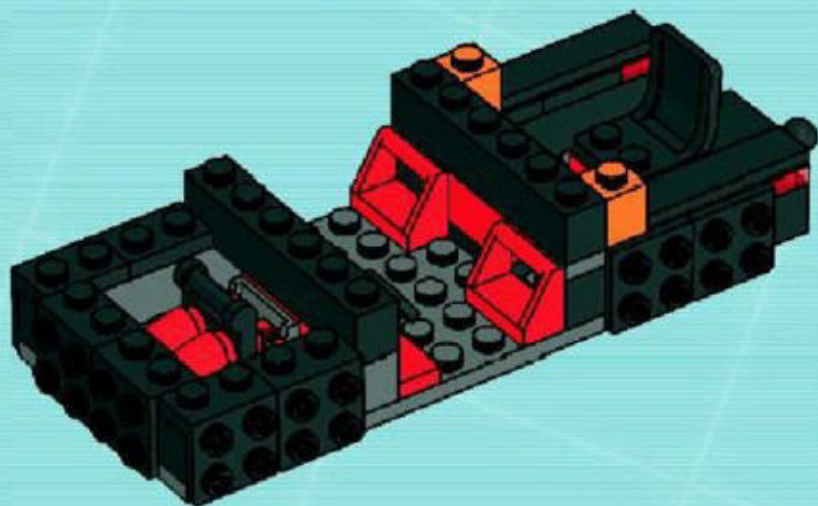



12

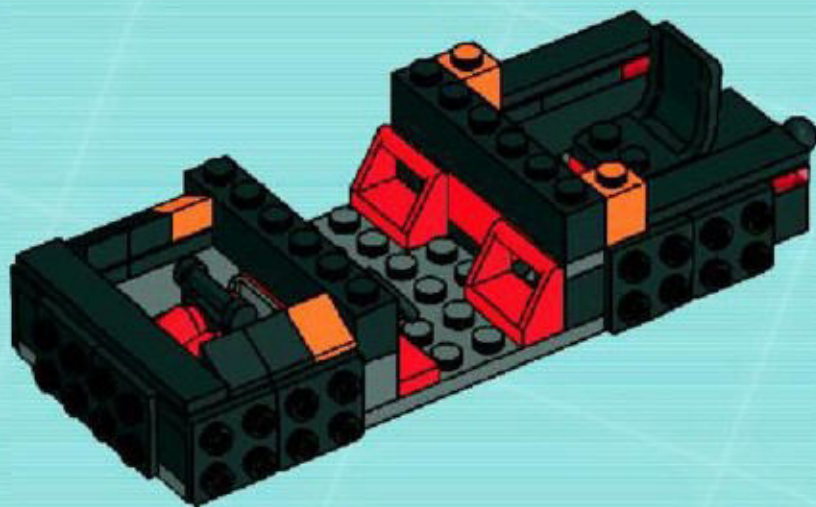



13

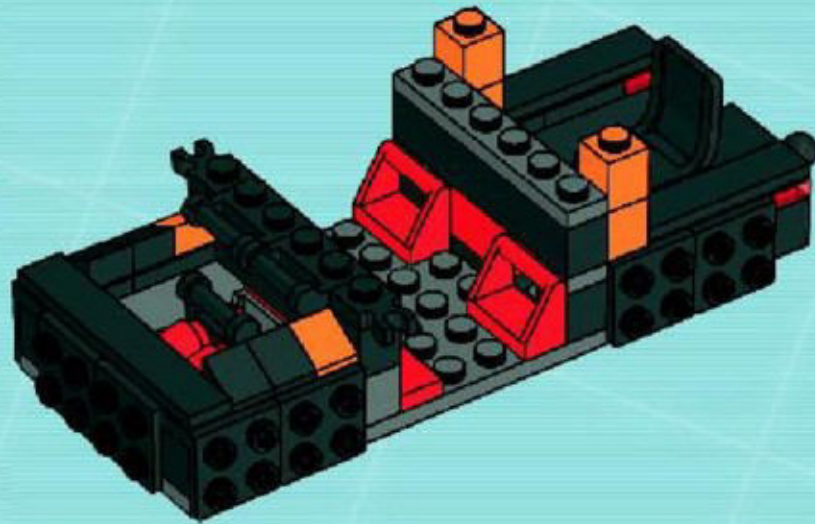



14

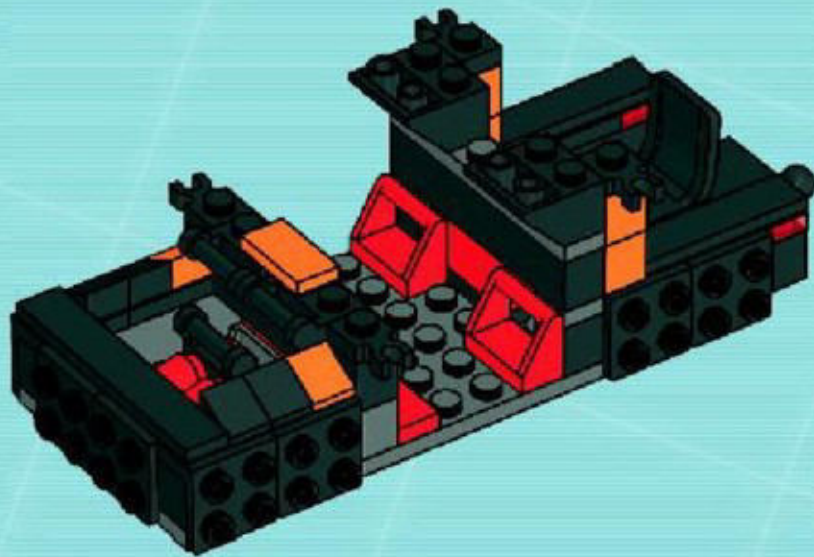



15

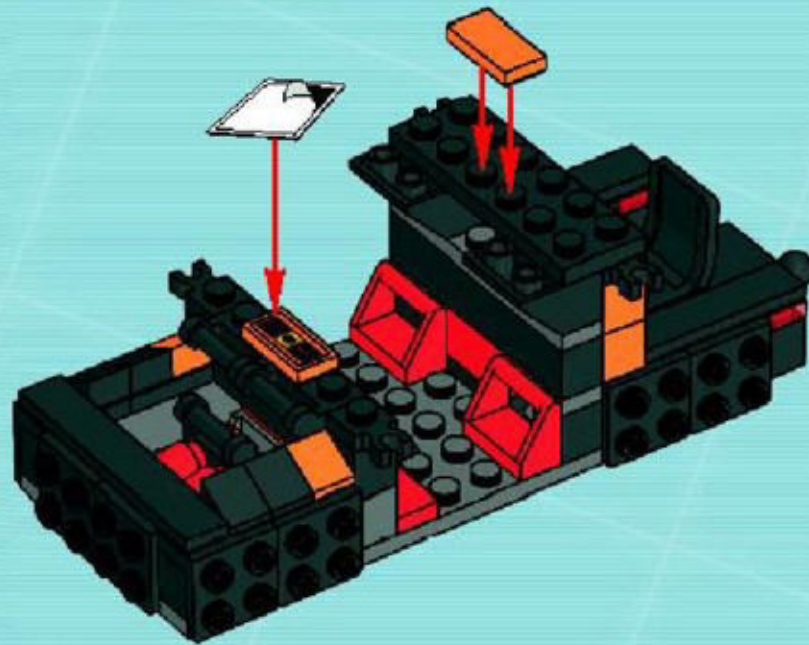

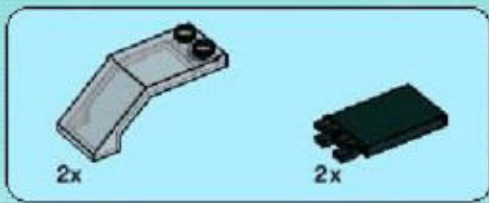

16

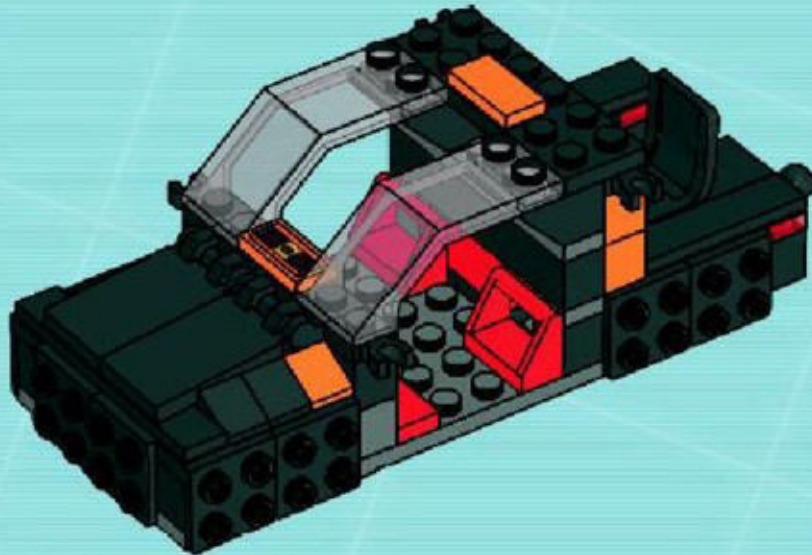

17

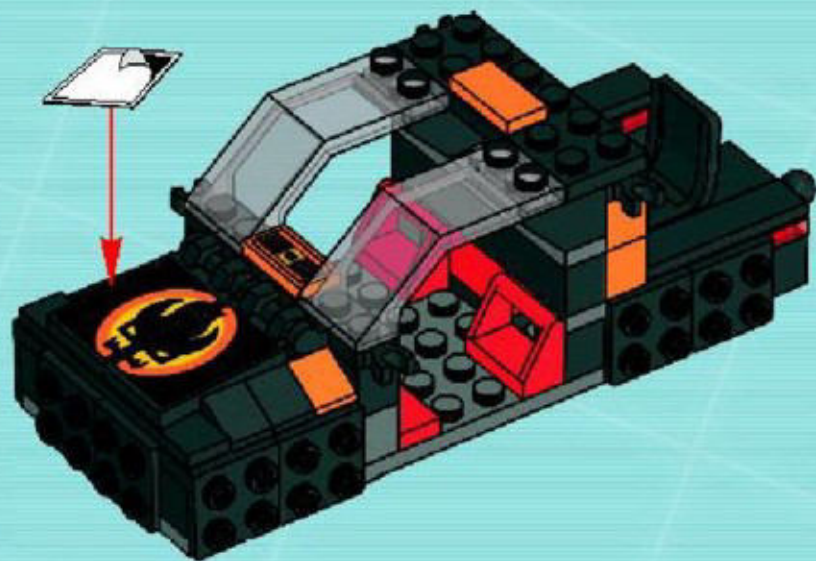

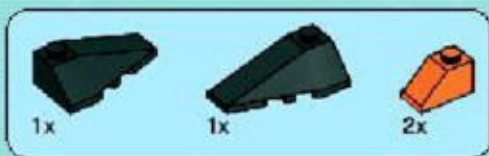

18

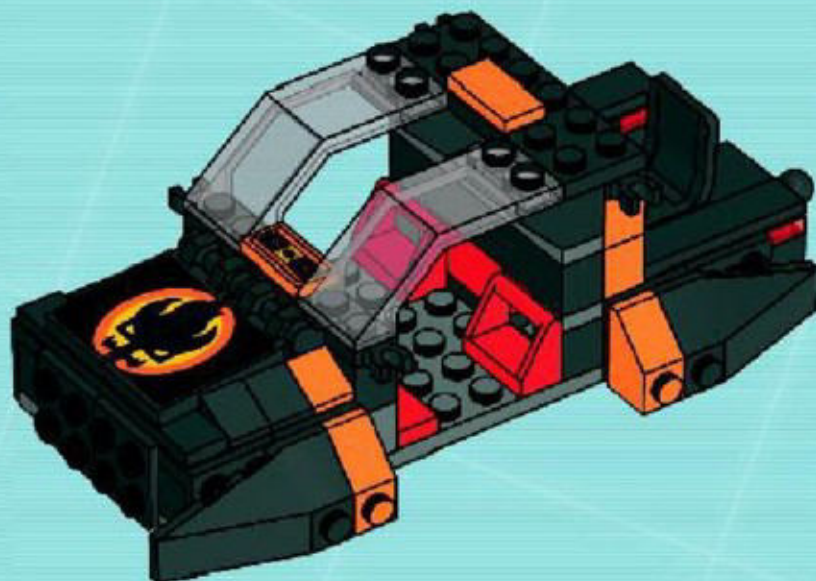

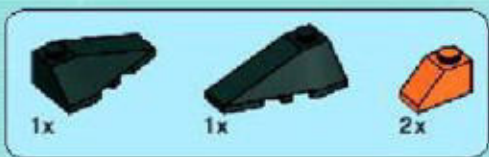

19

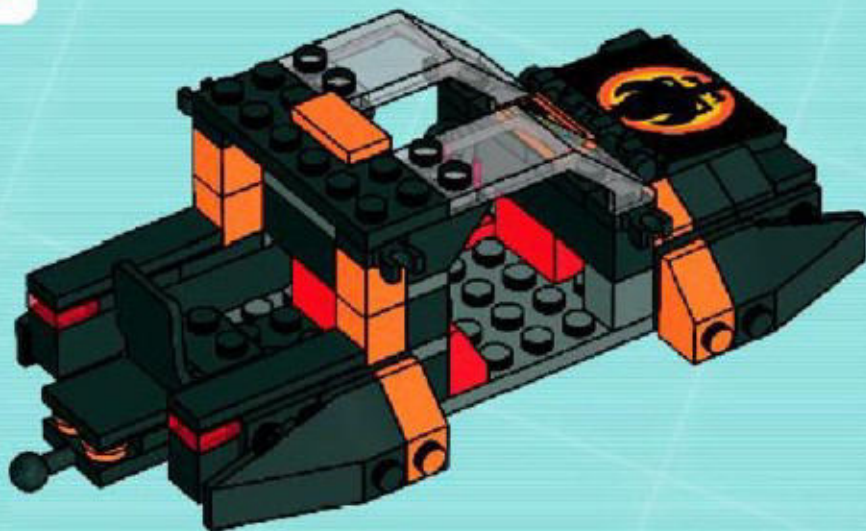

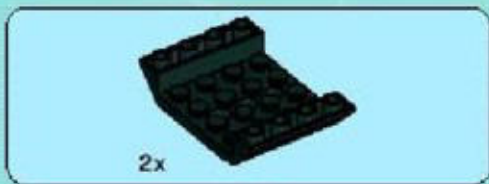

1

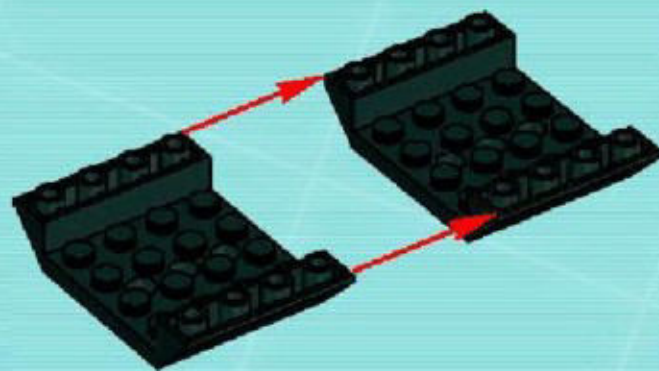

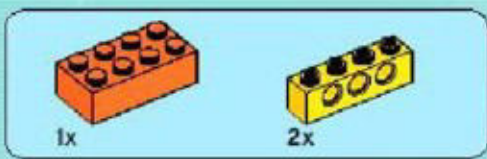

2



3

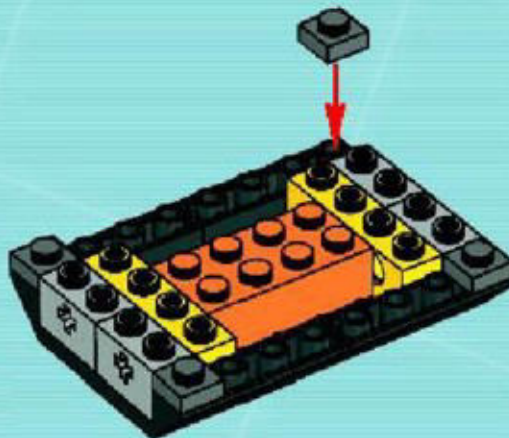



4



20

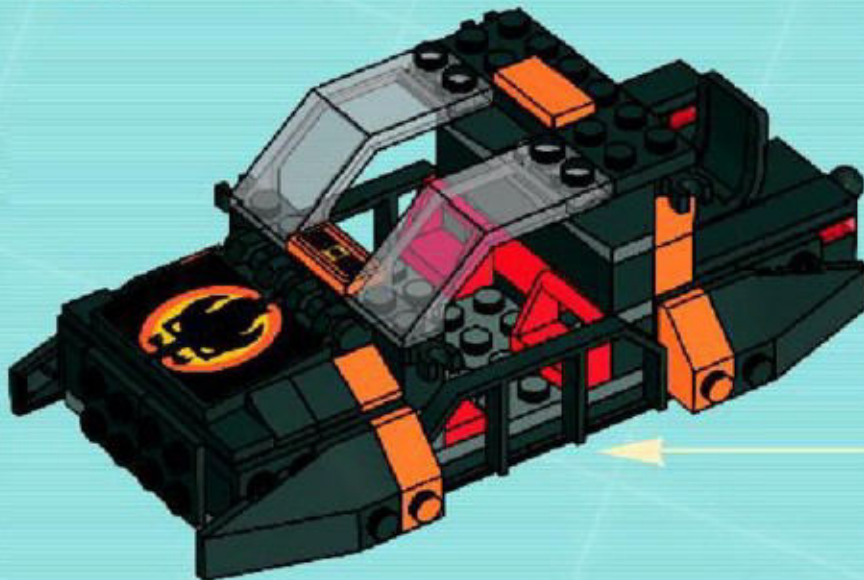



1



2

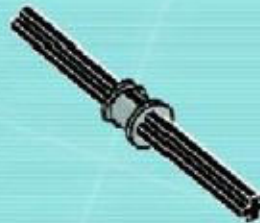



4

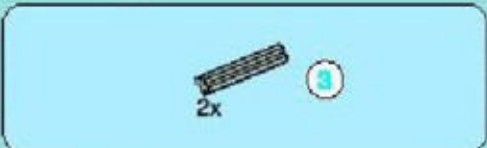
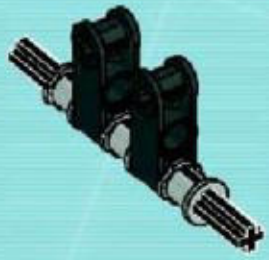

5

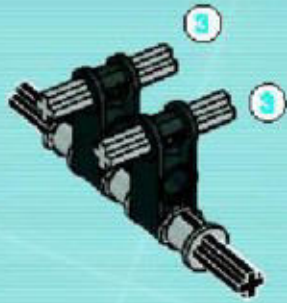



6

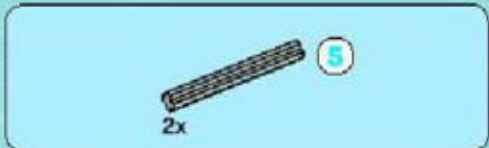

7





8

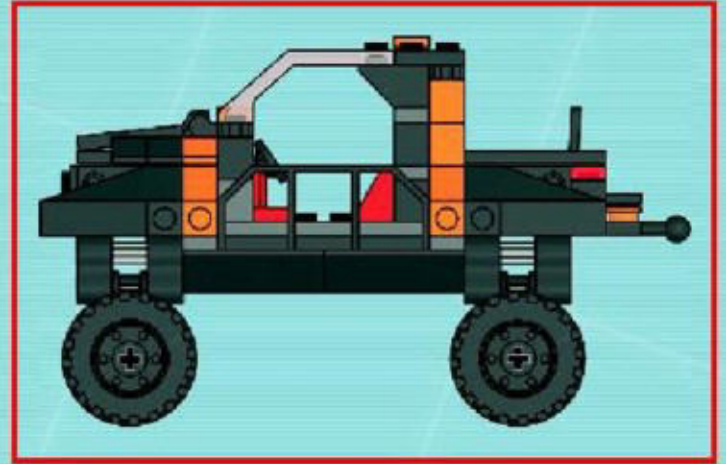

21

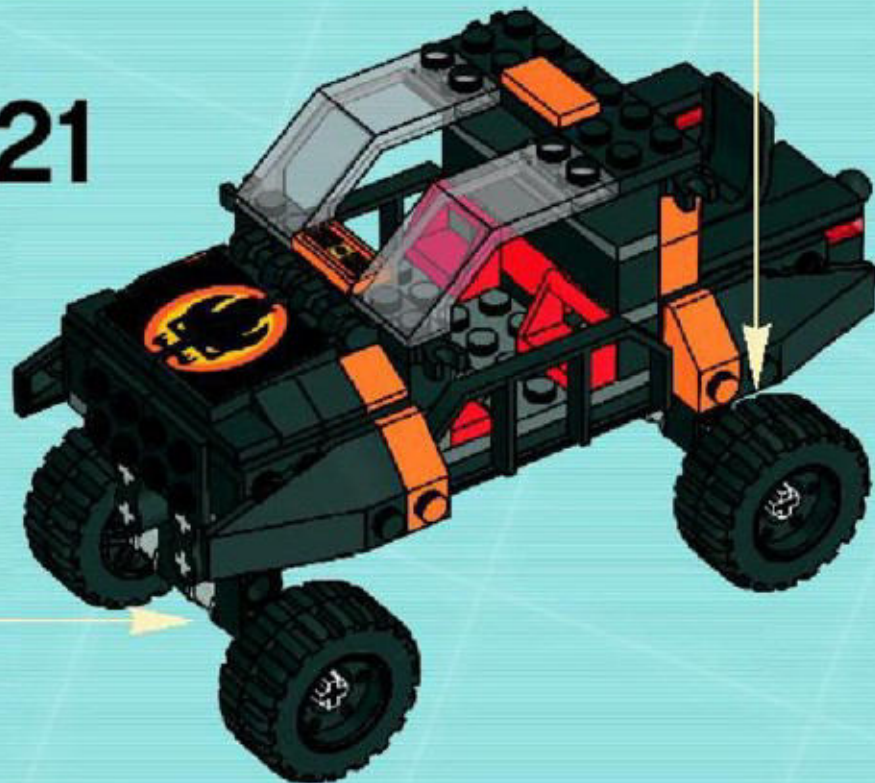

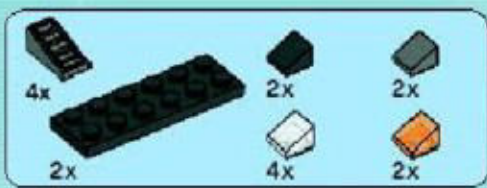

22

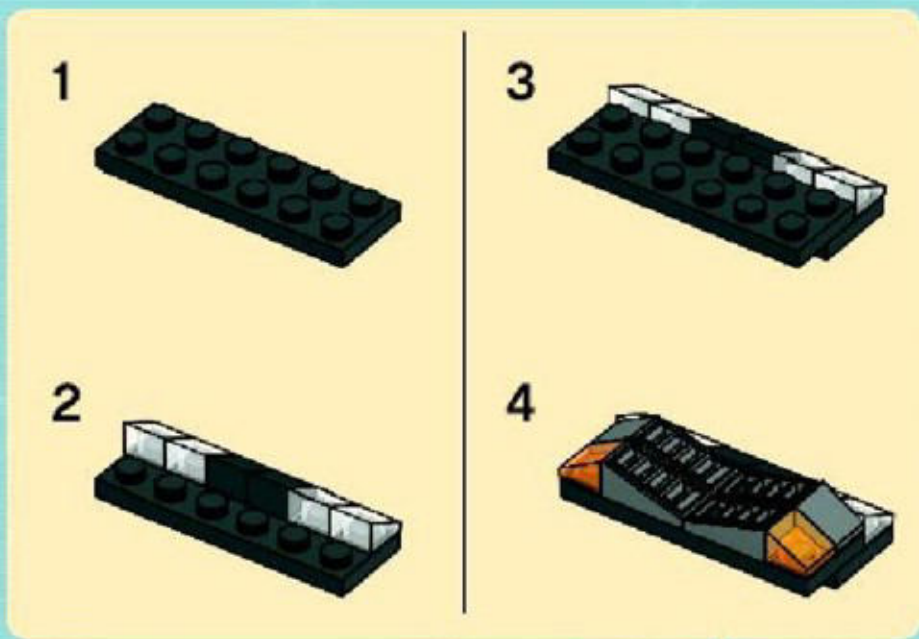



2x



2x

23

1

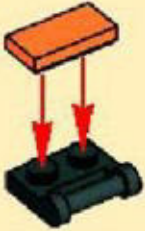

2



1

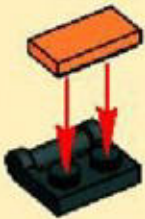

2

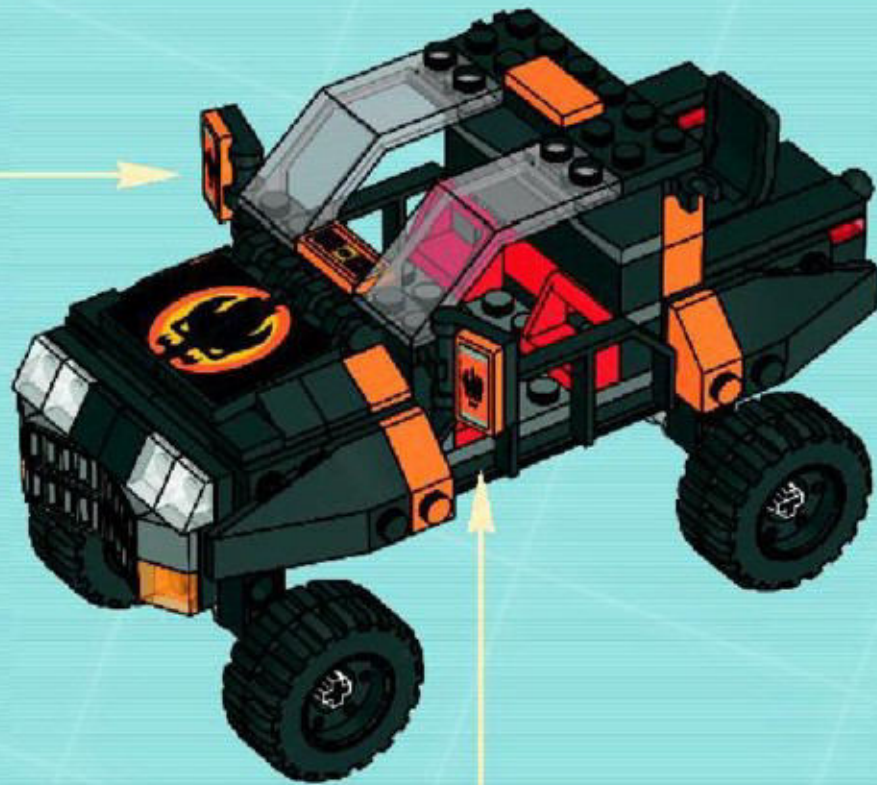



24

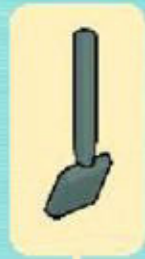

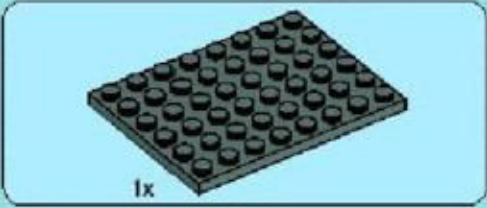

1

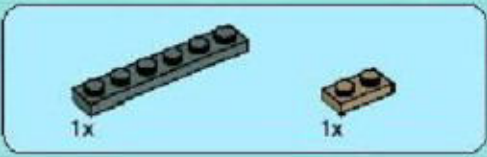
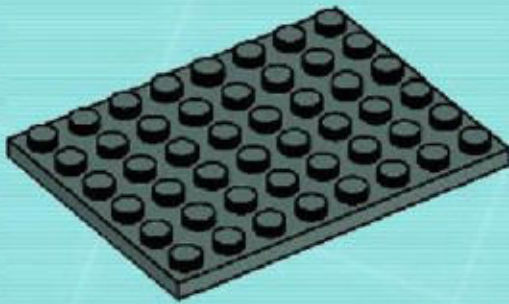

2

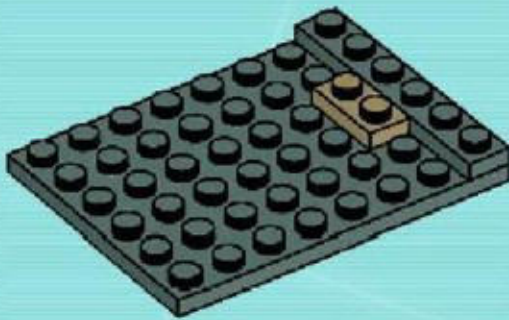



3

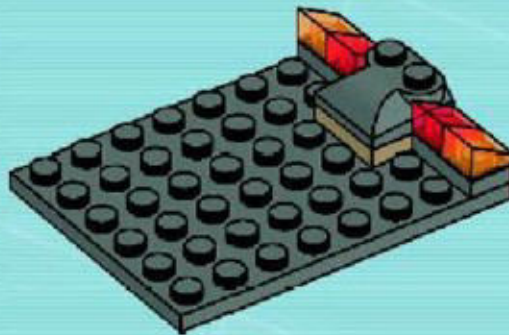

4

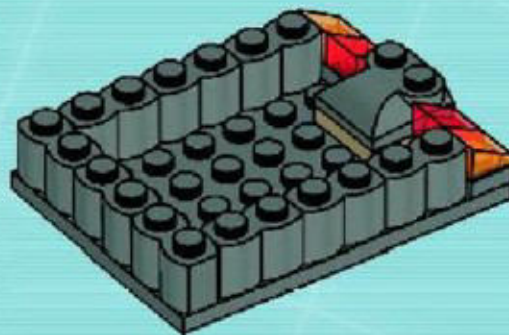

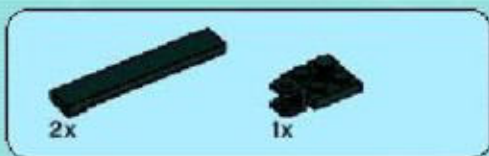

5

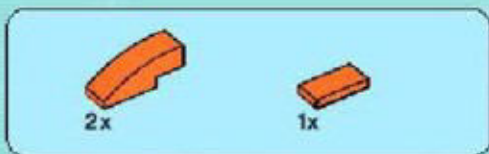
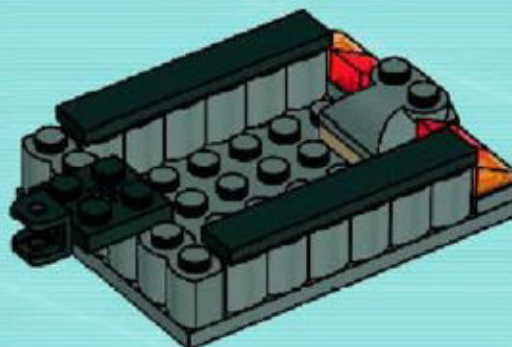

6

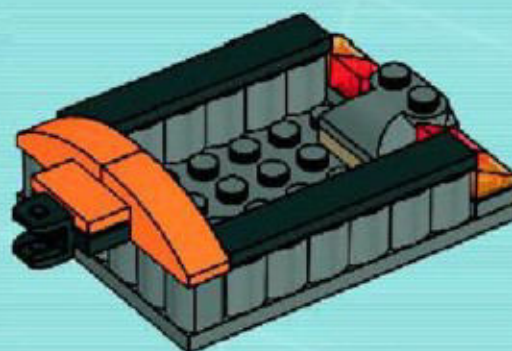

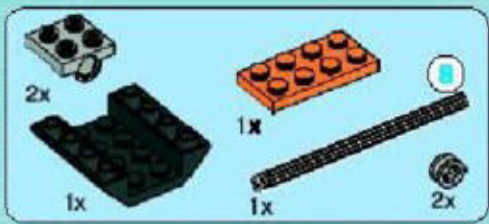

7

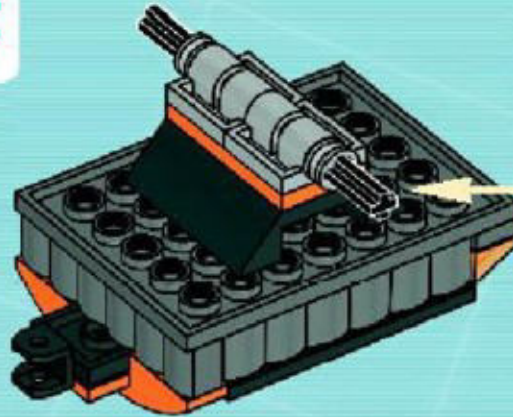
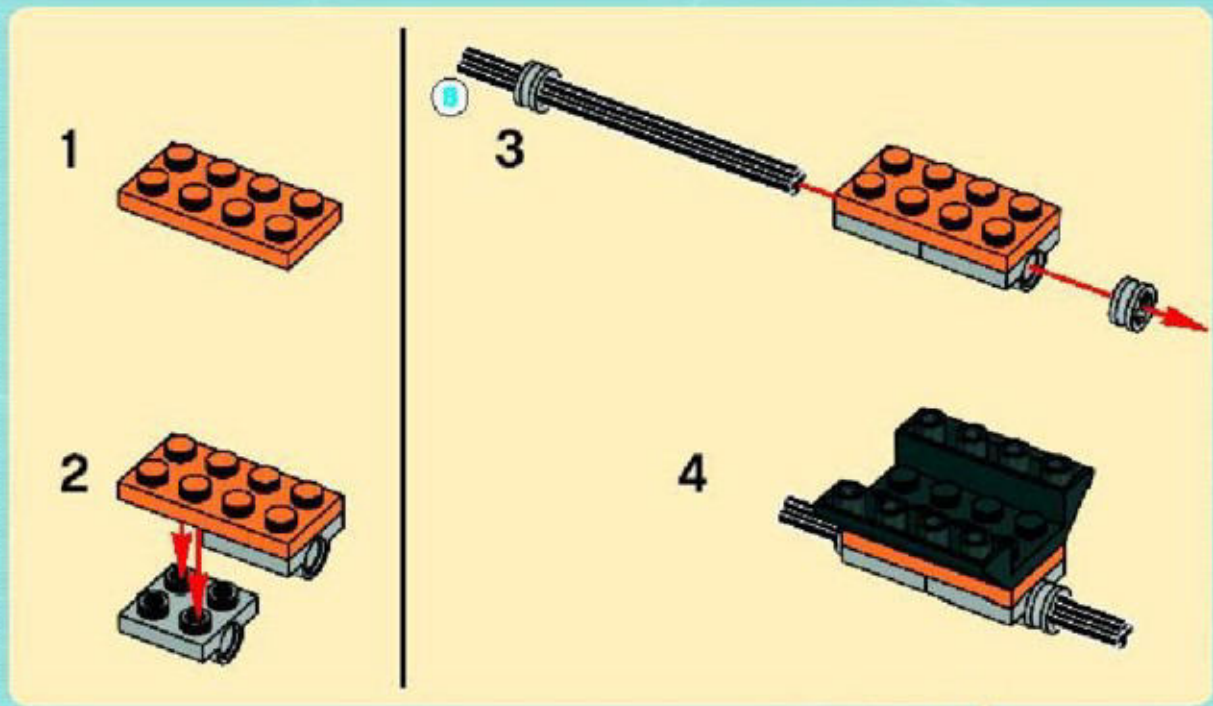

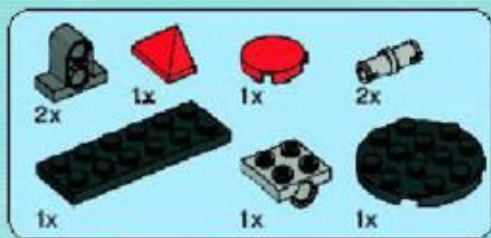

8

1



2

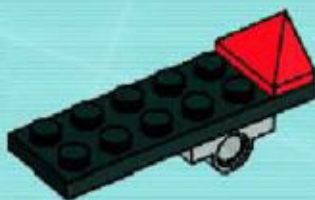

3

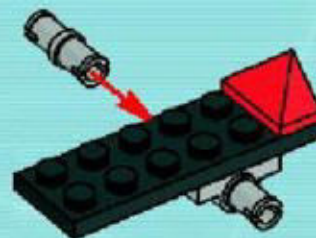

4

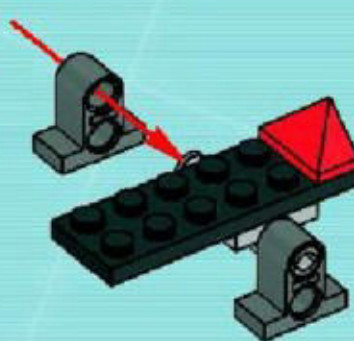

5



6



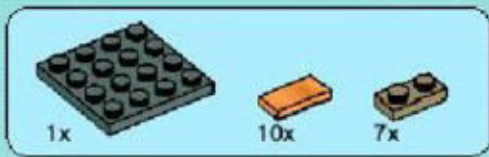

9

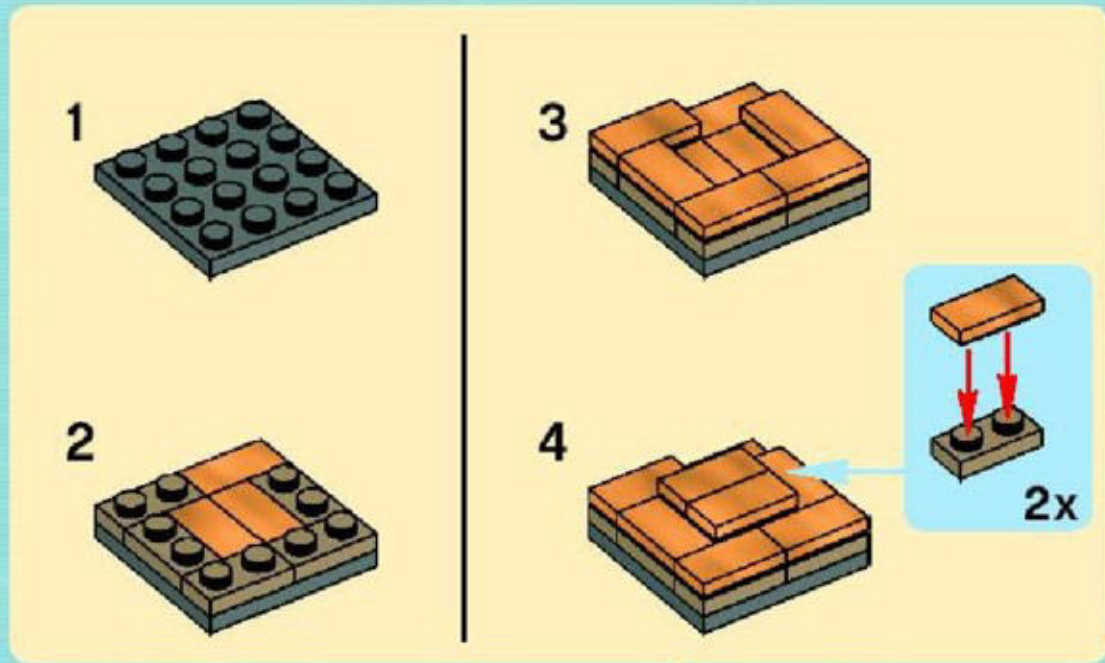



10

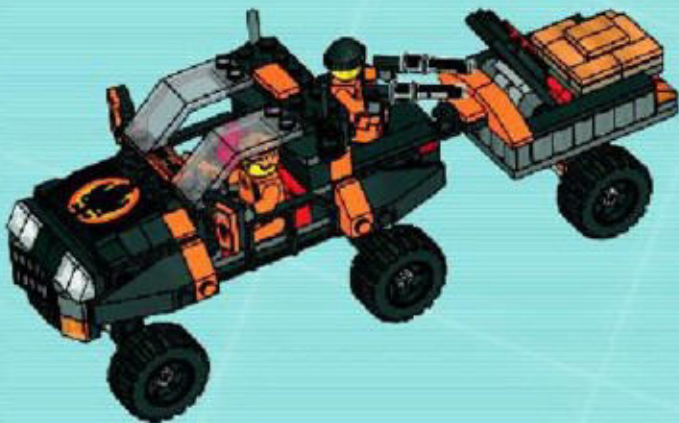

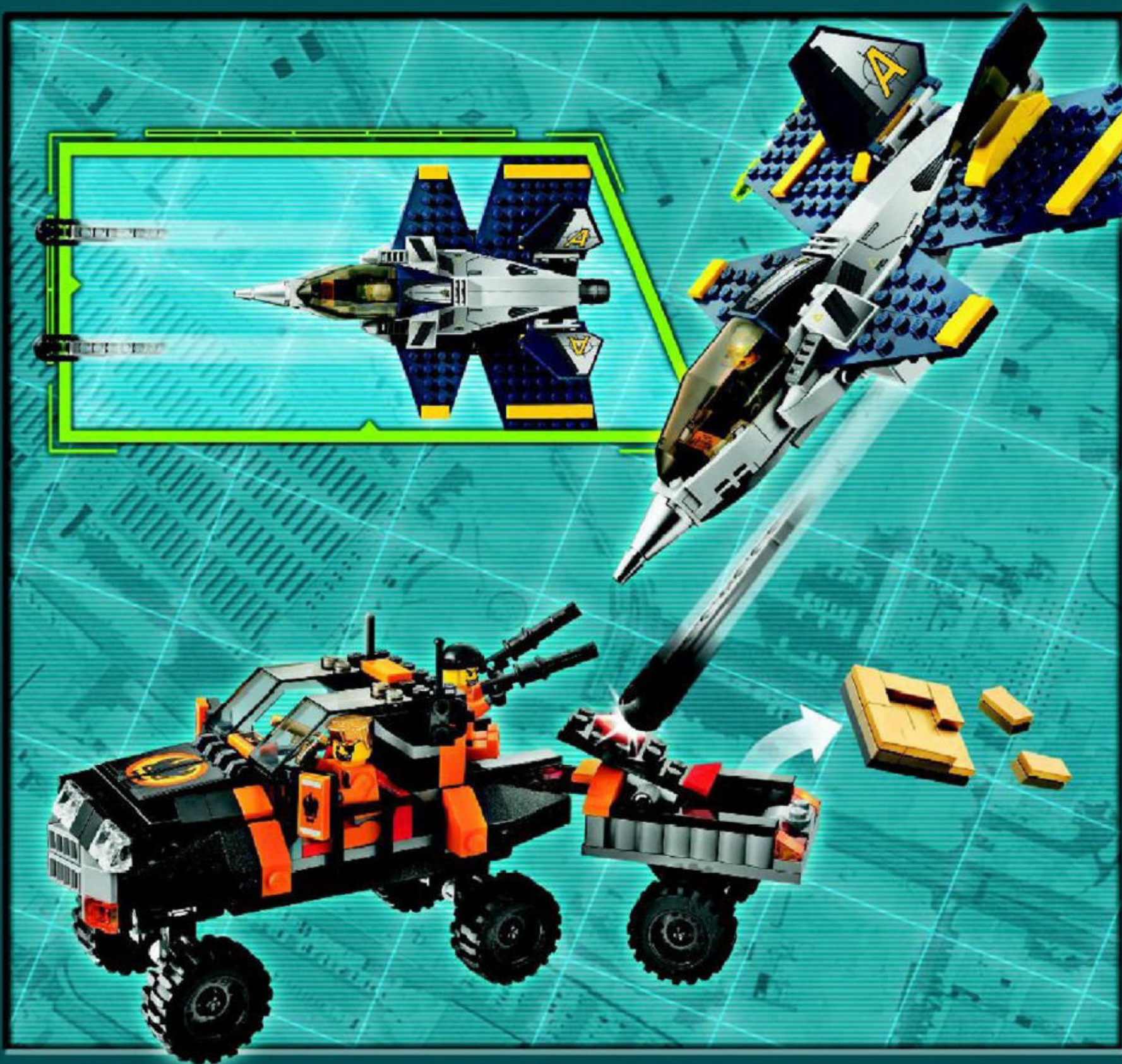





Customer Service
Kundenservice
Service Consommateurs
Servicio Al Consumidor
www.lego.com/service or dial





AGENTS

NAME:

AGENT CHASE

STATUS:



8634 *



8635 *



8632 *



8631 *



8630 *



8633 *







CHOOSE YOUR MISSION

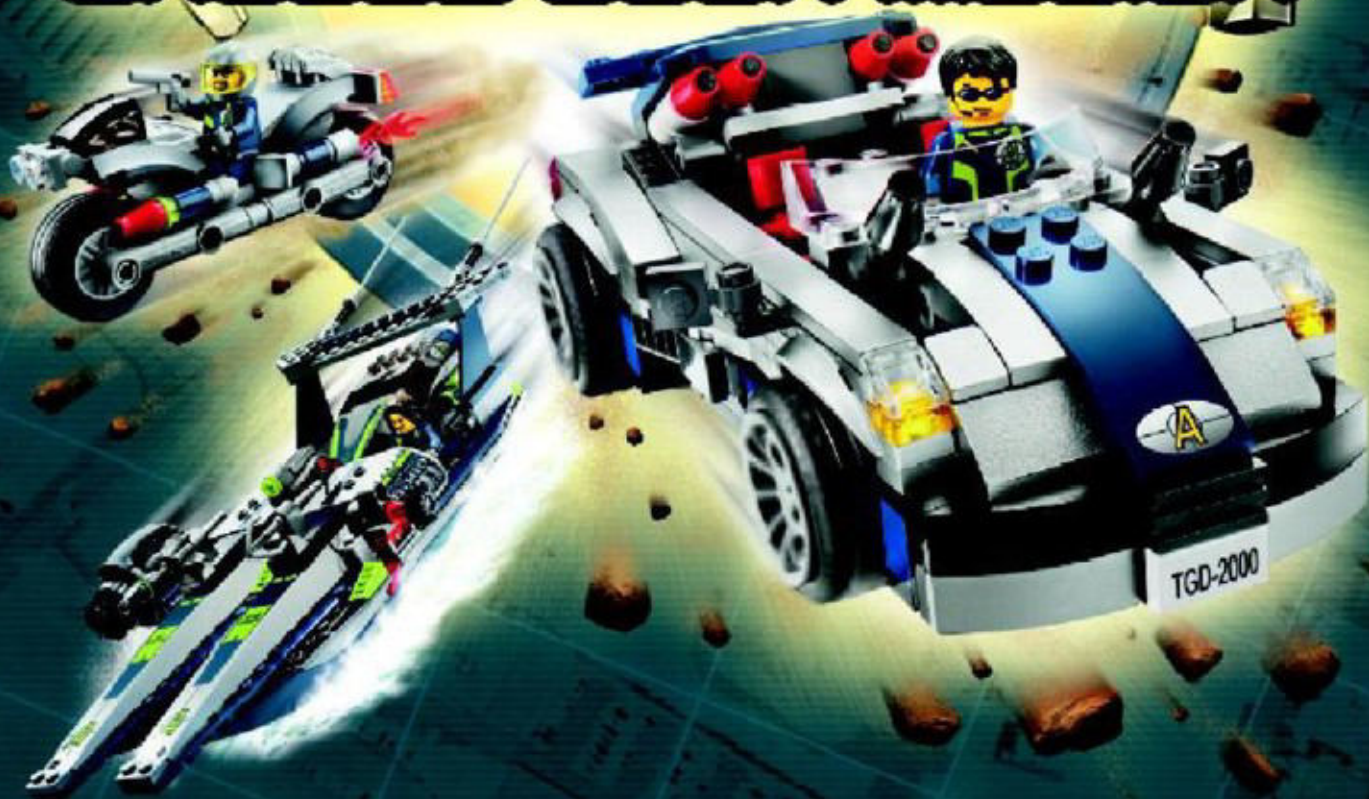

www.acnielsen.aim.dk/LEGO



WIN LEGO® PRODUCTS

No purchase necessary.
Open to residents of all countries where
not prohibited.
Go to www. for official rules and details.

WIN LEGO® PRODUCTEN

Kopen niet nodig.
Open voor alle leeftijden, en in alle landen
waar geen verbod geldt.
Ga naar www. voor officiële regels en details.

GEWINNE LEGO® PRODUKTE

Die Teilnahme am Gewinnspielführt zu
keinerlei Kaufverpflichtungen.
Sie können in allen nicht ausgeschlossenen
Ländern teilnehmen.
Die offiziellen Regeln und nähere Informationen
finden Sie unter www.

GAGNE DES PRODUITS LEGO®

Aucun achat n'est nécessaire.
Ouvert à tous les âges et aux résidents de
tous les pays, sauf en cas d'interdiction.
Rendez-vous sur www. pour obtenir plus
de détails et le règlement officiel.

レゴ®製品を「当てよう」

購入は不要です
禁止されていない限り、あらゆる
年代およびあらゆる国の居住者の
方々にご利用いただけます。
公認規則および詳細につきましては、
www.をご覧ください

